



RADIO'S LIVEST MAGAZINE

Special  
**RADIO-SERVICE**  
Number

# Radio-Craft

July  
25 Cents  
Canada 30c

HUGO GERNSBACK Editor



**The TRAVELING SERVICE MAN**

See Page 10



*FRIGNONE*

**The Ideal Radio Service Shop—A Free-for-All Service Men's Contest  
How to Make: A Shop Analyzer Panel; Portable Test Unit; 1-Tube Set**



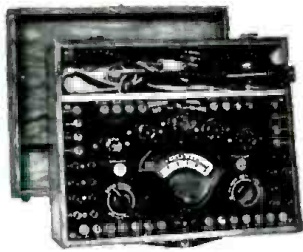

**SUPREME 339—DE LUXE ANALYZER**

A super-analyzer with direct resistance ranges up to 20 Megs, with self-contained power supply and many other features . \$39.95

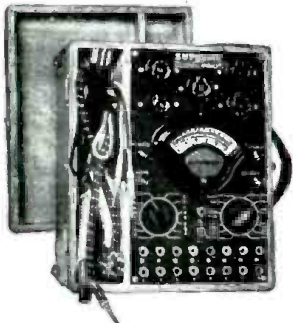

**SUPREME 339—STANDARD ANALYZER**

A new Free Reference Point Analyzer—the most outstanding value in the low price field . . \$29.95



**SUPREME 89—STANDARD TUBE TESTER**

A new low priced Tube Tester, featuring Supreme's famous Neonized leakage test . . . . . \$34.95

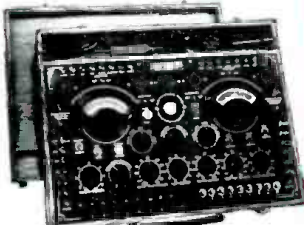

**SUPREME 385—AUTOMATIC**

A multi-unit instrument, combining features of 339—DeLux Analyzer and 89—DeLux Tube Tester, plus other flexibility features possible only through Supreme's exclusive uni-construction . . . . . \$77.95

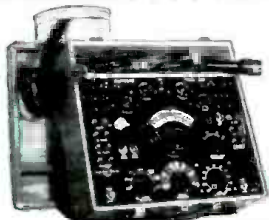

**SUPREME 391—P. A. ANALYZER**

A new analyzer especially designed for servicing sound film equipment and public address systems. \$69.95

**SUPREME 189—SIGNAL GENERATOR**  
Electron-coupled Circuit. 4 controls. 3 tubes. Completely new design . . . . . \$36.95

# HERE THEY COME!

The Most **SENSATIONAL** instruments in radio—

In last month's magazines Supreme promised instruments of the most startling design for service, speed and precision. Instruments offering many new features, in addition to new all-metal tube testing. We present them to you through your jobber's show rooms, confident that you will find our promises more than fulfilled.

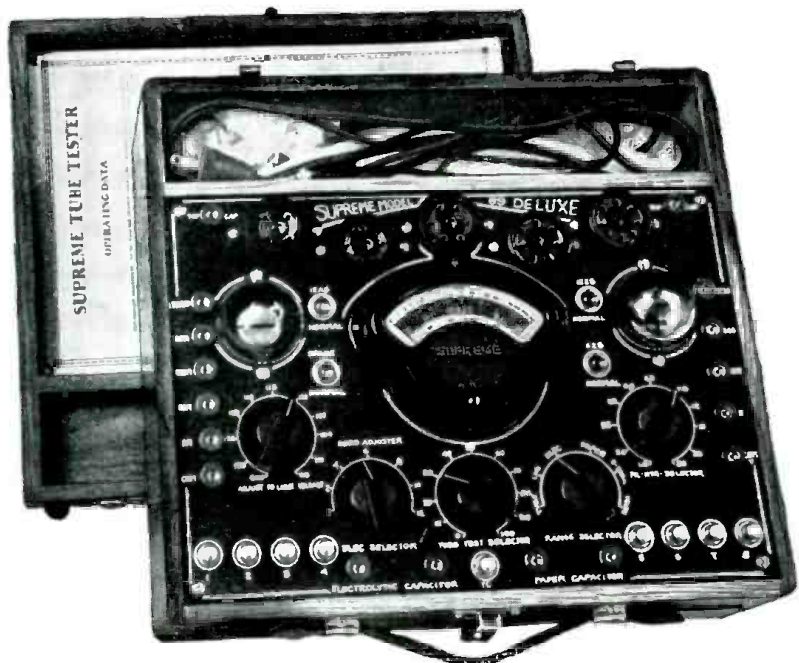

**Supreme 89—DeLux Tube Tester, \$45.95**

Dealers Net Cash Wholesale Price

An outstanding example of Supreme engineering ingenuity. Listen to these features: A general utility tester; a tube tester with English reading scale, testing all tubes including new all metal 8 prongs; Neon tube leakage tester; Neon condenser tester; Electrolytic condenser tester with English reading scale. 4 range volt meter for point-to-point testing; 3 range Ohmmeter and 2 range Megohmmeter. Resistance ranges to 20 Megohms are with self contained power supply.

Wide awake, professional radio-men won't wait a day to enjoy the pride of possession and servicing superiority of the ultra modern Supreme 89-DeLux.

## Turns Instruments Inside Out

For the first time the service-man can know exactly what he is getting in an instrument before he buys. Send the coupon for the free Supreme Technical Manual of the Instrument or instruments of your choice. Written by engineers who have done the service-man's work and speak his language, these manuals virtually turn the instrument inside out and through clear, service-man's English and simple illustrations explain every circuit. Instead of advertising catch phrases and sales ballyhoo we are giving you the real dope. Send the coupon now, no obligation.



**SUPREME INSTRUMENTS CORP.,**  
529 Supreme Bldg., Greenwood, Miss.

Send me the complete illustrated Technical Manual on Instruments checked below:

Supreme 89—DeLux Tube Tester  
 Supreme 89—Standard Tube Tester  
 Supreme 385—Automatic  
 Supreme 189—Signal Generator  
 Supreme 339—DeLux Analyzer  
 Supreme 339—Standard Analyzer  
 Supreme 391—P. A. Analyzer

Name \_\_\_\_\_  
 Address \_\_\_\_\_  
 Town \_\_\_\_\_ State \_\_\_\_\_  
 Jobber Preference \_\_\_\_\_

# NOW — GET INTO ONE OF THESE BIG PAY FIELDS!

CHOOSE ONE OF THESE COURSES  
PAY FOR YOUR TRAINING AFTER YOU GRADUATE IN RADIO OR ELECTRICITY

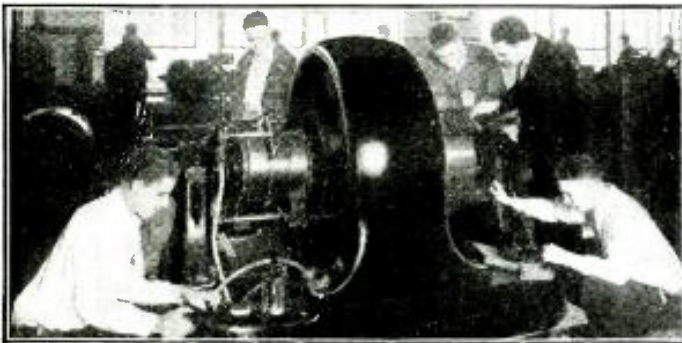

Students Testing a Synchronous Converter in Coyne Shops

## Amazingly Easy Way to Get Into ELECTRICITY

Dissatisfied with your job? Not making enough money? Then let me show you an amazingly easy way to get into ELECTRICITY, where thousands of Trained Men are drawing Big Pay every week. **Coyne** has been training ambitious fellows for the Electrical Industry since 1899. **12 weeks' training here in my shops**—by actual work on real dynamos, engines, power plants, autos, switchboards, transmitting stations, everything from door-bells to full-sized power and lighting plants — will give you the start you need.

### LEARN NOW—PAY ME LATER for YOUR ELECTRICAL or RADIO TRAINING!

You can get **Coyne** Training in **Electricity** or **Radio** without starting to pay me back until FIVE MONTHS from the date you start school, and then I give you over a year to complete your payments! That's my LATEST GREATEST OFFER! If you're ambitious enough to send in the coupon below, I'll explain my plan.

#### Practical Work in Coyne Shops

It's EASY to learn a BIG-PAY TRADE with my "Learn-by-Doing" method. Not by books, not by correspondence, but by ACTUAL PRACTICAL WORK JUST LIKE YOU WOULD DO ON THE JOB. That's why many concerns endorse Coyne and prefer **Coyne** Trained graduates.

#### Many Earn While Learning

If you're short of funds, you can still get Coyne training. My plan makes it possible to get **Coyne** Training with very little money. Many students earn a part of their living expenses doing part-



Student Operating Radio Control and Mixing Panel in Coyne Shops

## Learn RADIO TELEVISION TALKING PICTURES

Prepare for jobs in Service Work, Broadcasting, Talking Pictures, Wireless Operating, etc. Get in on the ground floor of Television! Radio has grown in a few years to a BILLION DOLLAR industry. There are many opportunities for the trained worker. Prepare for them now by **10 weeks of actual shop work at Coyne**, building real radio sets, doing radio wiring, testing, trouble shooting, repairing and servicing, working on real Talking Picture and Television equipment.

time work while here. We'll help you and do our best to get you a part-time job if you need it—and then give you Lifetime Employment Service after graduation. **Coyne** Employment Service produces results. You receive this service absolutely FREE as a Coyne graduate.

#### Real Jobs - Good Money - Quick!

"Coyne Training has certainly paid for itself many times in increased salary," writes Paul W. Holton, Ohio. "Coyne Training got me this job which has a wonderful future," says Sherman Penney, Florida. Hundreds of successful graduates boast Coyne. What they have done, you, too, should be able to do.

#### Get Pay-Raising Facts Free

Select the training you like best—Electricity or Radio—then mail one of the coupons below. I'll send you either my BIG FREE ELECTRICAL BOOK or MY BIG FREE RADIO-TELEVISION BOOK, whichever you prefer. No cost or obligation. Do it today.

### MAIL ONLY THIS COUPON FOR FREE ELECTRICAL BOOK

H. C. LEWIS, President  
Coyne Electrical School, Dept. B5-88  
500 SOUTH PAULINA STREET, CHICAGO, ILLINOIS

Send me your big Free Electrical Book and full details of your "Pay-Tuition-After-Graduation" Plan. This does not obligate me.

Name.....  
Address.....  
City..... State.....

### MAIL ONLY THIS COUPON FOR FREE RADIO BOOK

H. C. LEWIS, President  
Coyne Radio School, Dept. B5-8H  
500 SOUTH PAULINA STREET, CHICAGO, ILLINOIS

Send me big Free Radio-Television-Talking Picture Book and details of your "Pay-Tuition-After-Graduation" Plan. This does not obligate me.

Name.....  
Address.....  
City..... State.....

Please Say That You Saw It in RADIO-CRAFT





## CONTENTS—JULY, 1935, ISSUE

Volume VII Number I

Editorial: The Radio Service Industry.....Hugo Gernsback	5
The Radio Month in Review.....	6
Radio Pictorial.....	8
RADIO-CRAFT Presents—The Traveling Radio Service Shop.....	10
The Limit of Amplification.....G. L. Pearson	10
International Radio Review.....	11
The Latest Radio Equipment.....	12
The Radio Service Business.....Wilhelm E. Schrage	13
Announcing—RADIO-CRAFT'S "Ideal Radio Service Shop" Contest—\$400 in Prizes!.....	14
How to Make a Perpetual Analyzer Panel.....Karl Frank	15
How to Make a Speaker Field Supply.....Edward M. Usher	16
A Multi-Tube Adapter.....Hermie D. Vogel	16
Short-Cuts in Radio.....	17
Practical Methods of Servicing "Noise," Part I.....Pietro Muscari	18
Make this "Service Man's Companion".....Canio Maggio	19
New Developments in Condenser Capacity and Leakage Testers.....R. O. Lund	20
How to Obtain High Fidelity.....Leon J. Littmann	20
Modern Service Methods and Equipment.....V. E. Jenkins	21
A Test Bench Giant Volt-Ohmmeter.....Jack Dahlstrom	21
Announcing—A Test Unit for Sound Systems, Part I.....Harold H. Shotwell	22
Basic Service Functions of the Signal Generator and Multimeter.....J. J. McCarthy	22
Important Facts About Group Hearing Aids.....Paul Bottorff	23
Service Aids for the Radio Man.....Stanley B. Valiulis	23
Deaf-Aid Equipment—A Service Market—Part II.....R. M. Gray	24
New Money-Making Possibilities in a Portable P.A. Demonstrator.....Charles R. Shaw	24
Construction and Use of a Bridge-Type Condenser Tester.....F. L. Sprayberry	25
How to Use the Selective Sideband Signal Generator in Radio Service Work.....W. Robert Dresser	25
A Modern Tube Tester—A Letter to a Tube Engineer.....J. R. Williams	26
How to Make a D.C. to A.C. Meter Converter Unit.....Milton J. Reiner	26
How to Make an A.C.-D.C. I-Tube "Deaf Aid".....J. B. Carter	27
Valuable "Decibel" Data.....I. A. Mitchell	27
The Need for a "Tube Analyzer".....H. M. Klotz	28
Radio Receiver Connections for "Cathode-Ray Alignment".....Alfred A. Ghirardi	28
A Beginner's Short-Wave Converter.....Hubert L. Shortt	29
How to Make a I-Tube Battery Set.....J. S. Caulfield	29
Readers' Department.....	30
The Listening Post for All-Wave DX-ers.....C. A. Morrison	31
Operating Notes.....	32
The "Ultra-Modern Superhet." Now All-Wave.....Clifford E. Denton	33
RADIO-CRAFT'S Information Bureau.....	34
ORSMA Members' Forum.....	35
RADIO SERVICE DATA SHEETS:	
No. 141—General Electric Model D-72.....	36
No. 142—Crosley Model 4B1; and "Centurion" Model 1014 10-Tube All-Wave Super.....	37
Technicians' Data Service.....	40

HUGO GERNSBACK, Editor-in-Chief

C. W. PALMER

Associate Editor

R. D. WASHBURNE, Technical Editor

J. S. CAULFIELD

Associate Editor

## TELEVISION— IN OUR NEXT ISSUE

Japan, Germany, Canada, England—these countries are all doing things and "going places," in a television way, but do you know *what* is happening in these Foreign climes? Do you know what *America* is doing in this field? See the forthcoming, Television Number of RADIO-CRAFT, in which will appear photographs and descriptions of the new and novel in television development.

Television undoubtedly is our next sphere of activity. Its growth on a healthy scale promises prosperity and employment to tens of thousands of persons in numerous walks of life; and its niche in home and industry will be of almost incalculable importance. Therefore, it behooves the progressive individual—be he technician, or otherwise—to study all the easily-digested, fundamental information now available on existing systems.

Service Men, Public Address Technicians, Radio Beginners, and all other classes of radio men will also find material of interest in the forthcoming issue of RADIO-CRAFT.

RADIO-CRAFT is published monthly, on the first of the month preceding that of date; its subscription price is \$2.50 per year. (In Canada and foreign countries, \$3.00 a year to cover additional postage.) Entered at the post office at Mount Morris, Ill., as second-class matter under the act of March 3, 1879.

Text and illustrations of this magazine are copyright and must not be reproduced without permission of the copyright owners. We are also agents for WONDER STORIES and EVERYDAY SCIENCE AND MECHANICS. Subscription to these magazines may be taken in combination with RADIO-CRAFT at reduced Club rates. Write for information.

Copyright 1935. Continental Publications, Inc.

HUGO GERNSBACK, President

I. S. MANHEIMER, Secretary

Published by Continental Publications, Inc. Publication office: 404 N. Wesley Ave., Mount Morris, Illinois. Editorial and Advertising Office: 99 Hudson Street, New York City. Chicago Advertising Office: L. F. McClure, 919 North Michigan Avenue, Chicago, Ill. Western Advertising Office: Loyd B. Chappell, 511 So. Alexandria St., Los Angeles, Calif.

European Agents:

London—Gorrings' American News Agency, 9A Green St., Leicester Square, London, W. C. 2.

Paris—Messageries Dawson, 4 Rue Faubourg, Poissonniere, Paris, France.



J. E. SMITH, Pres.  
National Radio Institute

# I WILL TRAIN YOU AT HOME IN SPARE TIME FOR A GOOD RADIO JOB!

**FREE BOOK TELLS HOW  
MAIL COUPON**



**Good Position Station  
WSMK**

"I have a good job, make a nice salary, and all my success is due to N.R.I. I am operator of Station WSMK. I highly recommend the N.R.I. Course. It enabled me to pass the Government examination for an operator's license." **JOHN HAJDUK, Jr.**, 21 Gerard Avenue, Southern Hills, Dayton, Ohio.

**\$18 a Week in Spare Time**

"Although I am doing only spare time Radio work, I have averaged \$18 a week. I recommend N.R.I. training. It is certainly a complete Course. In a short time it will take a man, give him a sound fundamental training in Radio theory, practice and design." **STEPHEN J. DRAPCHATY**, 407 Wunderlich Ave., Barberton, Ohio.

**Netts about \$50 a Week besides Sales**

"I have been getting along fine. I average ten calls a week, which nets me about \$50, not counting profits on sales. I have serviced almost every make of set and have earned more than I ever expected. I owe my success to the N.R.I. and its wonderful Course." **BERNARD COSTA**, 150 Franklin St., Brooklyn, N.Y.

## FREE LESSON

**On Radio Set Servicing and Rebuilding**

I'll PROVE my Course is WHAT YOU NEED to master Radio. Send coupon for FREE lesson. "Direct Stage by Stage Elimination Method of Trouble Shooting." This interesting lesson shows many ways to correct every-day Radio troubles. Get acquainted with N. R. I. Training. See how well the lessons are written—how PRACTICAL they are. You'll quickly see why so many of my students have become Radio Experts and now earn two or three times their former pay. See for yourself. Get the sample lesson FREE.

Act today for better pay. Act today to break away from a low pay, no-future job. Act to get away from having to skimp, scrape to pay your bills. Mail coupon for my free 64-page book. It tells you how I will train you at home in your spare time to be a Radio Expert; about my training that has doubled and tripled the pay of many.

**Many Radio Experts make  
\$40, \$60, \$75 a Week**

Consider these facts—think of the good jobs they stand for. Over 17,000,000 Radio sets in use, over 600 broadcasting stations, over 40 large manufacturers of Radio sets, over 3,000 manufacturers of parts, over 100 Police Departments Radio equipped, airplanes and airports Radio equipped. Thousands of ships touching every seaport of the world are Radio equipped. Over 35,000 stores selling sets and parts, about 2,000,000 autos Radio equipped and about 20,000,000 unequipped. Loud speaker systems wherever people gather, indoors and outdoors. Commercial Radio stations dotting our coast lines. Radio a big industry—is growing bigger fast. A few hundred \$40, \$60, \$75 a week jobs, have grown to thousands.

**Get ready now for Jobs like these**

A spare time or full time service shop; installing, maintaining, operating—broadcast, aviation, commercial, ship, television and police stations. A Radio retail business of your own. Installing, maintaining, servicing, loud speaker systems. A service or sales job with a store or jobber. I'll train you for good jobs in every branch of Radio.

**Many make \$5, \$10, \$15 a week extra  
in Spare Time While Learning**

Every neighborhood can use a good part time serviceman. I'll start giving you special instruction material, plans, ideas, the lay you enroll, for making money in spare time. Get my book—read how many of my students make \$200 to \$1,000 in their spare time while learning. Stanley Tulk, 2705 Hector Street, Montreal, Canada, writes—"I have been doing so much service work I haven't had time to study. In two months, I made about \$200 in spare time." Lloyd V. Sternberg, 217 Fourth Avenue, Willmar, Minn., tells me—"I earned enough in spare time to pay for my Course. In one month I earned \$125 in spare time." Yes, my training pays!

**Your money back if not satisfied**

I'll make this agreement with you. If you are not entirely satisfied with my Lesson and Instruction Service when you finish, I'll refund your tuition.

**Find out what Radio Offers**

Mail the coupon. My book of information on Radio's spare time and full time opportunities is free to any ambitious fellow over 15. Read what Radio offers you. Read about the training I offer you. Read letters from graduates—what they are doing and making. There's no obligation. Mail coupon in an envelope or paste it on a postal card—NOW.

**J. E. SMITH, President  
National Radio Institute, Dept. 5GX  
Washington, D. C.**



**SAVE MONEY—LEARN AT HOME**

**Special Equipment Gives You  
Practical Experience**

Hold your job. No need to leave home and spend a lot of money to be a Radio Expert. I'll train you quickly and inexpensively right at home in your spare time. You don't need a high school or college education. Many of my successful graduates didn't finish grade school. My practical 50-50 method of training—half with lessons, half with Radio equipment—gives you broad, practical experience—makes learning at home easy, fascinating, practical and rapid. There is opportunity for you in Radio. Old jobs are becoming more complicated—many need better trained men. New developments are making new jobs. Short wave, loud speaker systems, police Radio, auto Radio, aviation Radio, television—Radio's newest uses are covered by my training. Here's a field that's growing. It is where you find growth that you find opportunity.

**I have doubled  
and tripled  
the salaries  
of many**



**MAIL THIS NOW!**

J. E. SMITH, President  
National Radio Institute, Department 5GX  
Washington, D. C.

Dear Mr. Smith: Without obligation, send me the sample lesson and your free book about spare time and full time Radio opportunities, and how I can train for them at home in spare time. (Please print plainly.)

NAME ..... AGE .....

ADDRESS .....

CITY .....

STATE ..... 39

**The Tested Way to BETTER PAY**

Please Say That You Saw It in RADIO-CRAFT



**- - - for the real  
servicing "dope"  
you can't find a  
better book!**

**N**O other radio book is comparable to the new 1935 OFFICIAL RADIO SERVICE MANUAL. In contents, in style of printing, in grade of paper, in illustrations there has never been published such a comprehensive volume

The 1935 Manual contains over a thousand pages—yet it is only 1¼ inches thick because it is printed on a special Bible stock which is an exceptionally good stock, yet one of the thinnest and most durable papers. This 1935 Manual is the most authentic and elaborate service guide ever used in the radio industry. Service Men and dealers who use this 1935 Manual are astonished by finding in it such a wealth of profitable service information which has never been published before.

**Contents of the 1935 Manual**

- Over 1,000 pages full of diagrams and essential information of manufactured receivers—only data of real use in servicing is included. This new Manual is really portable since it is extremely thin and light as well.
- Volume V continues where the preceding manual left off.
- Many circuits of old sets are included.
- Service Men know every set has certain weak points which are really the cause of trouble. Whenever the information could be obtained, these weaknesses with their cures are printed right with the circuits. This is an entirely new and valuable addition to the Manual.
- All the latest receivers are included—all-wave sets, short-wave sets, auto-radio sets, midjet and cigar-box sets, etc., as well as P. A. amplifiers and equipment, and commercial servicing instruments.
- The cumulative index is even more complete than before; including cross-reference to sets sold under different names and type numbers.
- Volume V includes resistance data; socket layouts; I.F. data; and voltage data.
- Tube data on latest tubes.
- Free question and answer service—as included in our latest three manuals.

**OVER 1,000 PAGES**

Over 3,000 Illustrations. Flexible, loose-leaf leatherette covers. Size 9x12"—only 1¼" thick

**GERNSBACK PUBLICATIONS, Inc.**  
99 Hudson Street New York, N. Y.



**What Others Say about this Manual:**

Norfolk, Va.  
I received the OFFICIAL RADIO SERVICE MANUALS ordered as per my letter of March 20, 1935 in good order. I am very well pleased with same, as it is a very valuable Radio Service data reference and guide.  
**ARTHUR J. FREENEY,**

Detroit, Mich.  
Received your 1935 OFFICIAL RADIO SERVICE MANUAL and certainly is something to rave about. It's great.  
**J. HEDKE,**

Stillwater, Maine.  
I have received the 1935 Manual, and I am very much pleased with my investment.  
**FRANKLIN J. HOLMES,**

Swift Current, Saskatchewan, Canada.  
I beg to acknowledge receipt of my 1935 issue of the OFFICIAL RADIO SERVICE MANUAL.  
Your Manual is fine, and would not be without any of them. The Manuals may be improved for Canadian use.  
**J. M. FORD,**

Kirbyville, Texas.  
I was an original subscriber to the Gernsback Manuals and the magazine, RADIO-CRAFT. They have been a great pleasure and help to me.  
**H. K. WHITTINGTON,**

Ironton, Mo.  
I have lately purchased the 1935 OFFICIAL RADIO SERVICE MANUALS and sure am proud of same. Wish to say also, that RADIO-CRAFT Magazine is a lifesaver for service men. I would not be without either.  
**THOMAS J. MAYES,**

**CLIP-MAIL COUPON TODAY!**

**GERNSBACK PUBLICATIONS Inc., 99 Hudson St., New York, N.Y.**  
Enclosed find my remittance of \$7.00 for which send me, POSTAGE PREPAID, One Copy of the 1935 OFFICIAL RADIO SERVICE MANUAL. [Send remittance by check or money order; or register letter if it contains cash, currency or unused U.S. postage stamps.]

NAME.....

ADDRESS.....

CITY..... STATE..... RC-7-35

Please Say That You Saw It in RADIO-CRAFT



# THE RADIO SERVICE INDUSTRY

An Editorial by HUGO GERNSBACK

**T**HE radio service business has now advanced to a position where it must be recognized as a separate industry. This is not just a fanciful title because, after all, an industry is unworthy of the name unless its dollar sales run up into the millions. The radio service industry is rapidly growing out of its babyhood—from practically nothing to where today it rivals many old and established industries.

Careful estimates from all sources reveal the amazing fact that during 1934 the *radio service industry* reached the astonishing total of approximately 30 million dollars in labor costs alone! This compares with, for instance (to name only a few), the carpet and rug industry of 30 million dollars, the packing box industry of 29 million dollars, and the canned fish industry of 26 million dollars—figuring labor costs only.

It should also be borne in mind that there are considerably over 20 million radio sets in this country. If every set were serviced only once a year, and if for his services the Service Man received only \$1.00—an extremely low figure for servicing the set—this alone would make a total of 20 million dollars!

But radio servicing, of course, goes much further than this. In the first place, the Service Man when he installs a radio set also installs the aerial and frequently sells the aerial equipment, too. When something goes wrong with the set he must not only repair it (charging for his labor), but he must also replace one or more parts—all of which runs into considerable figures. Then, there is the tube item, which runs into the sum of between 10 and 12 millions of dollars for replacements made by Service Men alone. Add to this parts, such as condensers, transformers, aerial equipment, and dozens of others, and we get a grand total which is between 45 and 50 millions of dollars per year expended by the radio service industry.

These are large, and to many people astonishing figures, but *they are only a beginning!* Remember, the past four years were "depression" years. We have not as yet seen good times. The years before 1929 were of relatively little importance to radio Service Men because in the first place there were no radio Service Men to speak of. The analyzer had not as yet been invented, and the few men who did repair work were ex-experimenters, amateurs, and inexperienced electricians who tried to do servicing with a few pieces of wire, a screwdriver and a pair of pliers.

Remember also, that A.C. sets only came into vogue about 1928 and that by 1929, the peak of our prosperous era, the set was still new and servicing began in earnest only about 1930.

Since that time, millions upon millions of radio sets have been sold to the public. In the nature of things, radio manufacturers are making their sets better and better and sets do not get out of order as easily as the set of 1928 and 1929, but as they grow older and begin to age the servicing problem becomes more acute; also, as receivers multiply

during the next decade, when there will be not less than 40 million sets in the American homes—and when, perhaps, television will have arrived—the radio servicing industry will become most substantial, and one to be reckoned with.

At the present time the radio service industry is divided into the following two classes: the servicing that is made by (1) radio dealers, and radio firms who employ Service Men themselves; and (2) independent Service Men who themselves make a direct living from their trade and who, except for an occasional helper, employ no other men.

It is probable that independent Service Men do the majority of the service business in the United States today, and this is particularly the case in the smaller communities.

In the larger centers we have, of course, the firms which do nothing except servicing and where a radio servicing establishment employs a number of Service Men to do the servicing for this firm, but as a rule it will be found that these firms are radio dealers as well, because they usually sell radio sets and other radio equipment. They, therefore, do not fall under the classification of independent Service Men.

In the beginning, the radio industry as a whole did not recognize the Service Man. He was regarded as a nuisance, and considered to be of little, if any, importance. This situation has been changed. Today, radio manufacturers realize that the servicing industry is one to be reckoned with and, as a general rule, both classes of Service Men are recognized today by the radio industry.

**There is no question but that the Service Man wields a powerful influence. He goes into the homes of the public and if he has a grievance against any radio manufacturer he can easily make or break that manufacturer if he is so minded. The serious Service Man who has the confidence of the public is always listened to and his recommendation of this or that set, or this or that brand of tube, bears a tremendous amount of weight. The public at large, ignorant of radio technicalities, is apt to be more influenced by the word of the Service Man than by the printed advertisement of a radio manufacturer. Not only that, but the Service Man is always in a position to make a demonstration and it has been said that he can make the public buy almost anything he recommends once he has obtained their confidence as a result of his experience and integrity.**

Due to the very wide field of "radio" applications embraced by the word "service," it is necessary to differentiate—radio (in the home), P.A., theatre and home talkies, electronic and therapy equipment, broadcast and other types of transmitter repair and maintenance, and airplane, centralized, marine and car "radio." Each of these subdivisions has its individual requirements as to service apparatus and technique, but the fundamental considerations of each are embraced in the above analysis of home radio service.

The radio service industry today is a force to be reckoned with, and its force and influence in this country are certain to increase from year to year.



# THE RADIO MONTH



In squawking about the metal tubes, Philco hopes to gain a very definite result.

## TUBE OR NOT TUBE

**"T**O BE or not to be," quoth Shakespeare. "Tube or not tube," quotes the tube industry today.

Last month, as an aftermath of the price-slashing war between several leading tube manufacturers, there was staged by the tube industry an entirely new spectacle that made the public sit up and take notice. The *all-metal* tube was the new radio infant that caused all the ruckus. No sooner had the General Electric Co. announced its new all-metal tube, (samples of which could not be obtained unless you bribed someone on the inside with heavy dough) than war was declared upon them by Philco, that lusty radio giant, which now sells more radio sets than anyone in the industry. The squawk that Philco let out was not only loud and lusty, but expensive as well, because it took the shape of a full page \$4,500.00 advertisement one morning last month in the *NEW YORK TIMES* (the text of this ad. is reproduced elsewhere in this issue).

G.E., of course, had the metal tube construction in preparation for a long time. Several years ago an all-metal tube was manufactured in England and became known under the name of Catkin. American manufacturers were distrustful of the English tube as in their opinion it had not been thoroughly engineered. That their judgment was right was subsequently demonstrated because Catkins were a big flop in England.

In the meantime, G.E.'s engineers were not loafing on the job and when they finally announced an all-metal tube, the radio industry did take heed because G.E. has never produced an unbaked job. They have usually taken their time, and when they finally announce an article, one may be reasonably certain that it will "stick."

All the objections that Philco brings

up against metal tubes may be discounted with a smile. They really amount to nothing. One thing seems certain, and that is, that beginning with this fall, the radio industry will gradually turn to metal tubes and inside of five years the glass tube will be as dead as the Dodo. That is our opinion.

So what is all the rumpus let loose by friend Philco? The chief reason is that it is no secret that G.E. is "after" Philco, and the new metal tube is one way to checkmate Philco in their ascendancy. If, as is certain, G.E. will spend a young fortune in popularizing their new metal tubes,—and if the public accepts them,—Philco, next year, will be in a bad shape unless they make their own metal tubes, which is doubtful. G.E. through its patents and other affiliations, will see to it that the tubes go only to "favored" concerns. So why the expensive advertising ballyhooing by Philco?

Philco knows that they will be at a disadvantage. They also know that G.E. does not cherish newspaper fireworks. The advertisement, therefore, has a certain nuisance value. When Philco and G.E. finally get around the table to discuss terms, things may be easier for Philco. The more noise you make, the more the other fellow will try to calm you down, particularly if the noise disturbs you.

With the result, (this is our own personal guess) that by next year, Philco too will be using all-metal tubes.

## WLW UP AGAIN!

**W**E announced last month that WLW, America's largest broadcast station, had been reduced to 50,000 watts, because of a complaint from Canada's CFRB.

However, during the past month, Powel Crosley, Jr., has succeeded in saving his \$500,000 station, by ingeniously erecting what is called a "suppressor" antenna (effective toward CFRB), which is a variation of the power reflector system used by KYW and WOR.

The appearance of WLW's new radiator system with the two "suppressors" in the foreground.

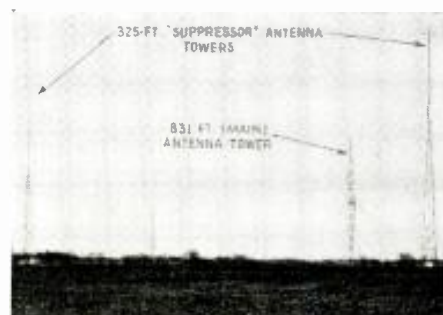

## ARMSTRONG INVENTION ENDS STATIC!

**A** NEW system of radio communication on ultra-high frequencies which overcomes to a great extent the bug-a-boos of static and fading was announced last month by Major Edwin H. Armstrong, veteran radio expert and inventor of regenerative, superheterodyne and super-regenerative circuits.

In announcing his new system, Major Armstrong said—"In this new system, instead of changing the strength of the incoming signal as is now the practice, the wavelength or frequency is altered in accordance with variations in the voice or music.

"Radio receivers now in use are, in engineering parlance 'amplitude modulated sets.' The new system features frequency modulation. It involves a method which translates at the receiver the variations in the frequency into variations of intensity, so that the signal may be detected.

"The incoming impulses consist of variations in frequency, and mixed with it are various disturbances such as static, tube noises and man-made interference. In the new system, all these currents are passed through a current limiting unit, designed to remove the amplitude variations. The signal is then led through a selective circuit which translates the variations of frequency into variations in amplitude from which sound is derived. That is where nature, which produces static, is foiled. It cannot duplicate this new type of signal."

It is expected that this system will advance television, since it permits extremely wide frequency modulation (150,000 cycles is used in Armstrong's experiments on 40 mcs.)

The modulator of the transmitter (above) and the receiver (below) of Armstrong's new system.

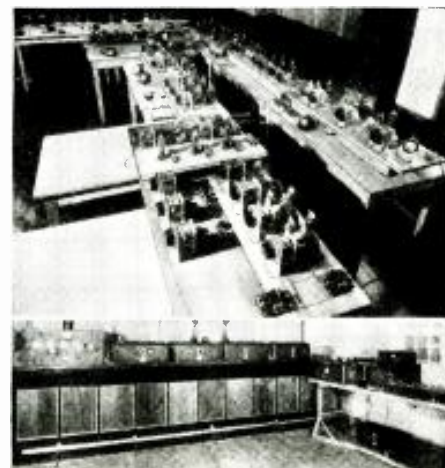



# IN REVIEW

Radio is now such a vast and diversified art it becomes necessary to make a general survey of important monthly developments. RADIO-CRAFT analyzes these developments and presents a review of those items which interest all.

## NEWSPAPERS KEEP RADIO NEWS SERVICE

**W**HEN the annual convention of the American Newspaper Publishers Association took place, last month, it was expected by everyone that fireworks would be heard regarding the radio newscasting situation.

It is a well known fact that the newspapers resent the inroads that radio stations have made in what they consider their property—that of disseminating news—and it is only recently that the two national networks were able to come to a temporary agreement which was satisfactory to both sides.

To the surprise of many, the convention meekly voted to continue the present agreements for another year. However, these agreements are obviously “sleeping dogs” which may start howling at any moment.

## RADIO AIDS FLOOD PATROL

**J**UST one more useful application of radio came to light last month—in the form of a radio device which sends a warning hours in advance of a flood crest. In some parts of the U.S., serious conditions arise from overflowing rivers which rise in such a short time that the inhabitants of the surrounding country do not have time to reach high country in time.

This new device sends signals at regular intervals which indicate the level of the water. Thus, a constant check can be made of fluctuations in the water height. The indicating instruments mount in the cylinder.

A radio flood indicator in a California stream.



## "BEST PROGRAM" AWARDS

**L**AST month, the newly formed Women's National Radio Committee presented four awards to broadcast stations for sponsored and non-sponsored programs, in a contest originated to stimulate an interest in bettering the quality of programs.

The Women's National Radio Committee claims the backing of over 10,000,000 women, throughout the U.S., and with the open support of Anning S. Prall, Chairman of the Federal Communications Commission, they wield a big club which NBC and CBS cannot afford to ignore.

The awards this year were divided equally between the two national networks, Columbia's "Concert Hall" and National's "You and Your Government" receiving scrolls for sustaining programs; and NBC's "General Motors Symphony Orchestra" and CBS "March of Time" taking the honors for sponsored programs.

Commissioner Prall, in presenting the scrolls said "The F.C.C. looks to station owners, not to sponsors of advertising, to present and broadcast programs in the public interest and therefore can only hold station owners responsible."

## STRATOSPHERE FLIGHT PLANNED

**L**ATE last month, news was received that the National Geographical Society in collaboration with the U.S. Army Air Corps and NBC planned to make a stratosphere flight, early in June. Two army fliers will pilot the balloon—Capt. A. W. Stevens and Capt. O. A. Anderson—and they will carry a complete radio broadcasting transmitter especially designed for the purpose, so that radio listeners can hear a description of the flight.

The stratosphere transmitter and receiver.



The Detroit News' plane and (insert) the reporter sending his "copy" to the city desk.

## THE AIR-RADIO REPORTER

**N**EWSPAPER reporters who fly to their assignments and report by radio are now being used by a Detroit newspaper. Last month, the DETROIT NEWS fitted up a modern plane with full radio transmitting and receiving equipment, as well as the usual typewriters and cameras used by reporters in their work. The transmitter was assigned the license WKFB and assigned a frequency of 2,150 kc. At Detroit's City Airport, another transmitter was installed (KHPMN) so that the four newspaper men "aloft" can keep in constant touch with the "city desk" of the paper.

This application of aviation and radio to newspaper work will, without doubt spread throughout the entire news-gathering industry—because of the ease with which it permits the reporters to get from place to place.

## CONNECTICUT ANTI-RADIO BILL DEAD

**I**N our last issue, we announced that the state legislature of Connecticut had introduced a bill to ban the use of auto-radio sets in cars.

However, during the past month, sufficient opposition was presented by the RMA and several well-known manufacturers of auto-radio sets to kill the bill. The hearing scheduled on the bill by the State Motor Vehicles Committee was attended by about 50 representatives of radio and automotive interests, but none were heard as an immediate announcement by the committee chairman stated that the author of the bill insisted on its withdrawal.

Note, however, that South Dakota has now joined several other states in prohibiting car S.-W. sets.



# RADIO PICTORIAL

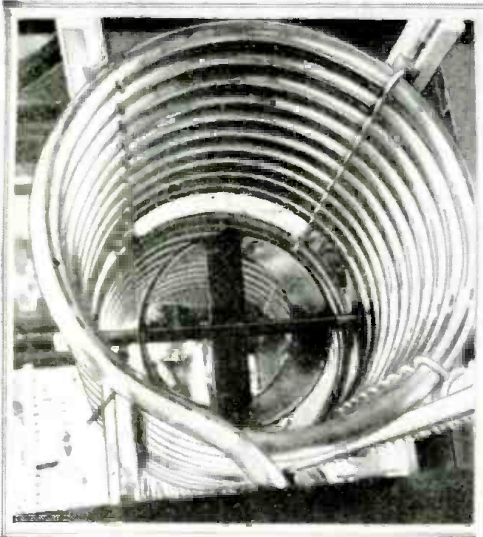

These are not drain pipes, above! It is a view inside the tuning coils of a powerful German short-wave transmitter.

To the right is one of the most luxuriously-equipped sound ad. trucks in the world. It weighs over 10 tons, and is equipped with modern broadcast facilities and a complete public address system; also, the very latest talking picture equipment, and a model home with all facilities!

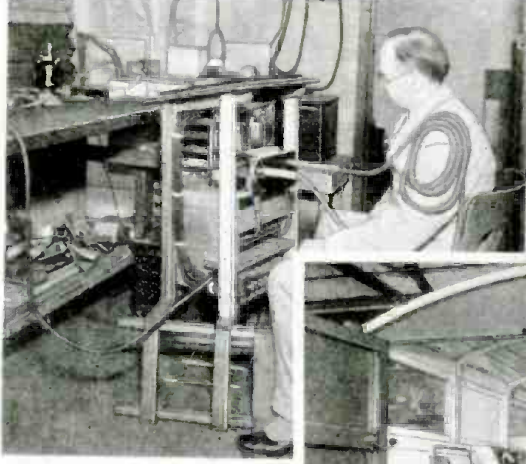

To the left is shown Dr. W. R. Whitney of the G.E. Co. receiving treatment for "bursitis" (cause of "stiff" shoulder) from high-frequency (short-wave) apparatus. Below is shown the motorized radio station which is used at emergency flying fields in Germany for air-plane guidance.



A Polish engineer was successful in building the tubeless amplifier shown above. With a phonograph pickup it operates a large speaker. The picture below shows how a film passes from the reel across the lens to the cathode-ray tube in a new English television system, which is claimed will bring talking pictures into the home.

One of the new radio cars of the Reichpost used to locate noise.



A new mirror oscillograph, shown below, has been developed by the Westinghouse E. & M. Co. The instrument may also be used as an ordinary voltmeter or ammeter. It is very compact. Note the comparative size of the slide rule in the foreground. A new type of galvanometer is also employed with a large viewing screen for making tracings.

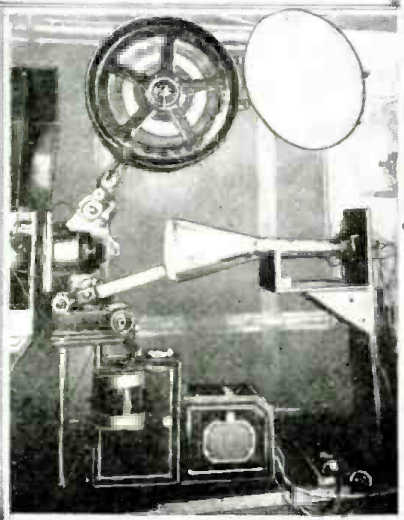

Three aerials (1, long wave; 1, S.-W. directionless; 1, S.-W. directive to America and S. Africa) of Berlin broadcaster "Deutschlandsender."

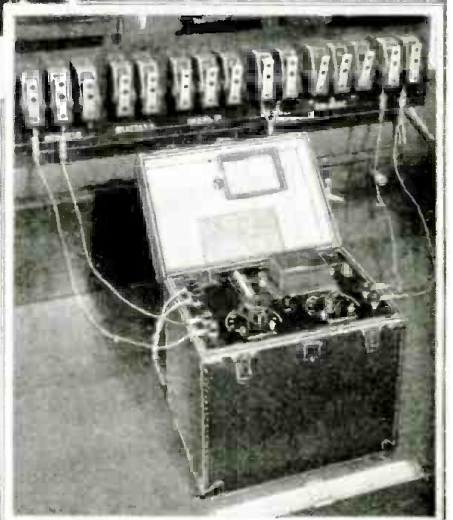
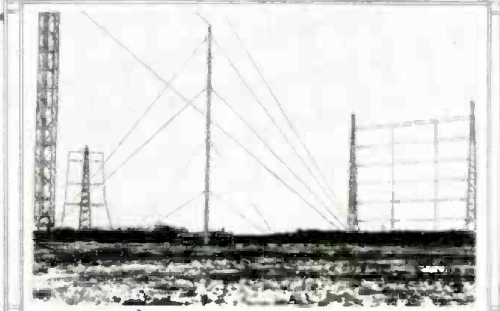





The pictures to the right and left and also the two directly below illustrate the essential parts of the Hammond Electric organ, which is a new musical instrument operating on a wholly novel principle. At the left is shown a view of the console which is built to conform to present organ standards and requires pipe organ  
(Continued on page 38)



An excellent idea of the smallness of the combination radio-phonograph is shown below. Note the size of the turntable with respect to the radio set. The radio chassis contains a high-quality 5-tube A.C.-D.C. superheterodyne circuit.

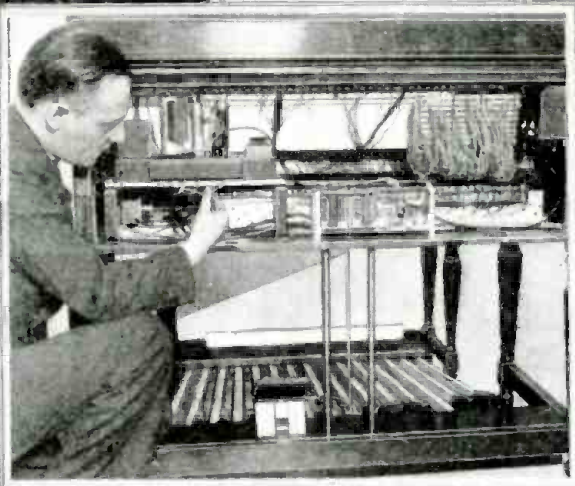

The miniature combination radio-phonograph shown below has a total weight of less than 14 lbs. It reproduces records and radio with amazing fidelity.



A view of the tone motor is shown above, while the details are shown below.

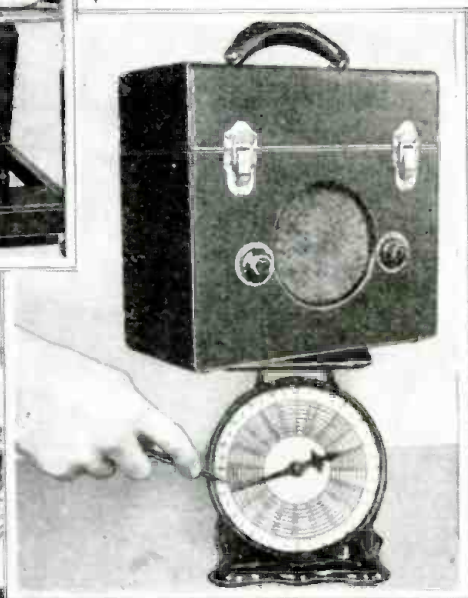

The rubber-band drive on the miniature radio-phonograph combination is clearly shown below. It drives both long- and short-playing records.

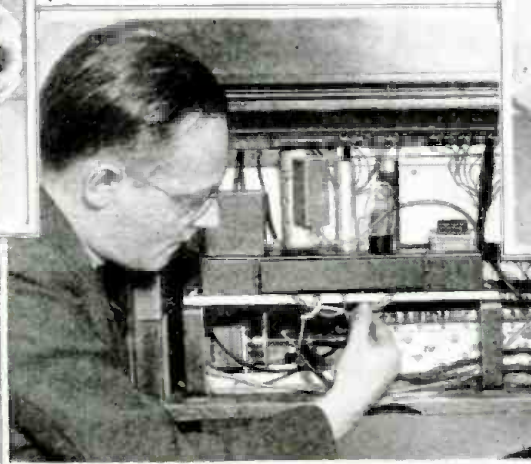

Closeup view of the "works" of the miniature radio-phonograph outfit is illustrated below. The tiny electric motor is also shown, which revolves the turntable at two different speeds for the long- and short-playing records.



The illustrations to the left and right show a novel combination radio-phonograph with many striking features. Construction is simplified by the use of a rubber-band in place of gears for driving the turntable. The long permanent magnet of the pickup provides added efficiency, and a balanced support for the needle. A 5-tube superhet. radio receiver is used.

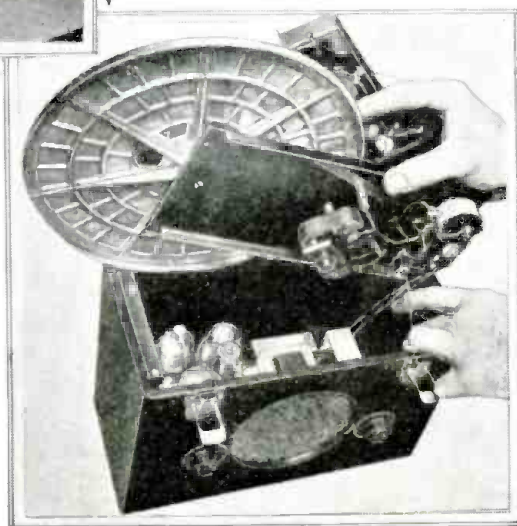

All photos by Halbran  
(Designed by Arthur C. Ansley.)



# RADIO-CRAFT PRESENTS— THE TRAVELING SERVICE SHOP

Bringing the mountain to Mohammed is now an aphorism in the service field, with the advent of the traveling service shop. All the conveniences of home are now offered.

**S**UMMERTIME has always been the "bad" period of the service business because of the general exodus of customers to vacationland. Many Service Men have tried to improve conditions by going after the trade of vacationists but they found that the cost of getting to and from the job wiped out any chance of a profit.

In analyzing this situation RADIO-CRAFT has found the answer in the "traveling service shop" depicted on the front cover of this issue, and reproduced on this page. This consists of nothing more than an automobile trailer fitted up with a service bench and all equipment for repairing a radio set on the premises. With such mobile equipment a Service Man has unlimited opportunities in developing a business, the surface of which has barely been scratched.

The size of the vacation market is clearly shown by the fact that approximately 25 per cent of the population (or about 30,000,000 people) take advantage of a vacation during the summer season. Therefore, with the advent of high-power broadcasting, and the improvements in summer radio programs and the design of small radio sets it is easy to visualize the tremendous size of this summer radio market.



The illustration shows the ideal "portable service shop" which is complete in every detail. With such equipment a Service Man can make a thorough repair job from fixing the cabinet to "lining-up" the set. However, if one's funds are limited we suggest the use of a small trailer that could be fixed with a drop-leaf work table and sufficient room for analyzer, tools, tubes and an assortment of parts. Since the majority of radio sets used by vacationists are battery operated, it is advisable to carry a few rental batteries.

Any Service Man who is a good mechanic can very easily make a trailer to accommodate a small shop. The chassis may be the rear end of any old car that can be picked up at an auto grave-yard. And although the body can be made of wood, we strongly advise metal for the best service.

In stocking the "shop," bear in mind that a wide variety of equipment and parts are necessary if you are to do a complete job on the "ground." This will require an investment slightly higher than the permanent radio shop. However, it has been proven that customers will gladly pay for fast service. Thus your prices and rates may be higher

(Continued on page 39)

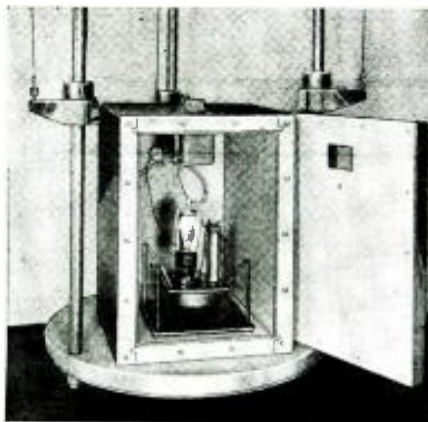

Tube under test, in a lead-lined shield

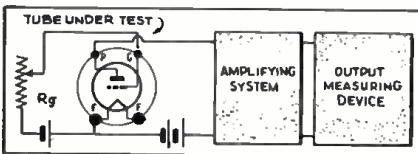

Above, measuring "thermal noise." Below, the noise curves of several tubes.

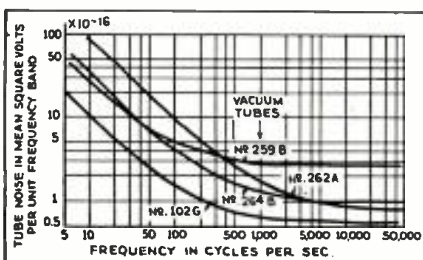

## THE LIMIT OF AMPLIFICATION

The "Nth" degree of amplification is limited by tube noise. Requirements for the low-noise tube are: low microphonic response, and grid current; high insulation, vacuum, and trans-conductance; and good temperature saturation.

G. L. PEARSON\*

**A** SMALL electrical signal can be amplified by vacuum tubes to any desired extent as long as the input voltage to the amplifier is large enough to over-ride the noises that are inherent in the circuit. Even when fluctuations in battery voltages, induction, microphonic effects, poor insulation, and other obvious causes are entirely eliminated, there are two fundamental sources of noise which remain, namely (1) thermal agitation of electricity in the external circuits and (2) voltage fluctuations within the vacuum tubes.

The impedance of the input circuit of high-gain amplifiers is often high or may effectively be made so by the use of a transformer. In this case, the contribution of noise from the vacuum tube is small compared with the noise arising from thermal agitation in the input circuit. This is a desirable condition since it furnishes the largest ratio of signal to noise for a given input pow-

er. Sometimes, however, the input impedance is perforce so small that the tube noise may be comparable with or greater than thermal agitation noise. Such conditions may arise, for example, in amplifiers where the frequency dealt with is high or the frequency range is wide, in which cases bridged capacities reduce the impedance. It is, therefore, desirable to know the noise level to be expected from different types of tubes that may be used in the first stage of high-gain amplifiers as well as to be able to calculate the thermal noise level of the input circuit.

The noise of thermal agitation, first discovered by J. B. Johnson (BELL LABS. RECORD, February 1927, page 185), arises from the fact that the electric charge in a conductor shares the thermal agitation of the molecules of the substance so that minute variations of potential difference are produced between the terminals of the conductor. The mean square thermal-noise voltage

(Continued on page 38)

\*Manufacturers name on request.



**RADIO-CRAFT** receives hundreds of magazines from all parts of the world. Since the cost of subscribing to each of these would be prohibitive for most radio men, we have arranged with technical translators to prepare reviews for our readers.

# INTERNATIONAL RADIO REVIEW

## LOUDSPEAKER IMPROVEMENTS

**T**WO English magazines contained hints for improving the response of radio receivers, in their latest issues. The first of these is **POPULAR WIRELESS** which printed a description of the idea illustrated in Fig. 1A and B. The author discovered that the "boom" in many sets is due, not to a natural resonance of the cabinet being at a particular bass frequency, so much as a "piston" action from the frame of the dynamic reproducer itself. In other words, the frame of the speaker sets up a synthetic vibration which is usually at some particular bass tone and this vibration forces the cabinet to vibrate at this frequency or one of its harmonics. The result is a peculiar "boomy" response.

The method of eliminating the effect is to mount the speaker on a floating baffle, so that the mechanical vibration of the speaker frame is not transmitted to the set cabinet. The details are evident from the illustrations.

The second scheme appeared in **WIRELESS WORLD** and is based on an idea somewhat similar to the "Infinite Baffle" described in the May 1935 issue of **RADIO-CRAFT**.

The speaker is mounted on a recessed baffle, in the set cabinet, and the entire back is packed with kapok (the mass of silky fibres within the seed pods of a certain tropical tree; used in mattresses pillows, etc.) stuffing, in order to "kill" the back wave. The front is also packed with kapok, to the shape indicated in the illustration, Fig. 1C.

As a means of spreading the high frequencies, a "deflector" is mounted directly in front of the cone. The details of this deflector appear in Fig. 1D. It is claimed that the high frequencies cover an angle of 140 degrees when this device is attached, while they covered only about 20 degrees before.

## NEW MIDGET TUBES

**T**HREE new tubes have just been introduced by an English tube manufacturer as announced in **PRACTICAL AND AMATEUR WIRELESS**. They are extreme-

ly small in size, as shown in Fig. A.

Two of these tubes are triodes, having amplification factors of 16 and 12 while the third is a screen-grid type supplying a voltage amplification of 360. Since the filament requirements are so small (2V. at .06-A.), these new tubes naturally open up many possibilities, such as pocket sets, police portable receivers, preamplifiers, etc., operating from lightweight batteries.

It is announced that the British Government has subjected these tubes to severe tests in the past few months and that they have proven entirely satisfactory. They are not available in the United States, of course.

## A FRENCH TEST UNIT

**T**O give an idea how European testing equipment compares with that available in the U.S., we are reprinting a picture and circuit of a new French set tester which appeared in a recent issue of **TOUTE LA RADIO**. This tester, which is evidently intended for bench use, incorporates a voltmeter, milliammeter, ohmmeter, capacity tester and emergency "B" power supply. A separate high-voltage winding (S) is provided in the power transformer of the latter unit for voltage break-down tests on condensers, insulation, etc.

## A SERVICE AID

**A**N English Trade magazine, "THE BROADCASTER AND WIRELESS RETAILER" recently carried an advertisement for a device which every Service Man can use to advantage on his test bench. It consists of a sturdily built "cradle" in which the set chassis is clamped while it is being serviced. A glance at the illustration, Fig. C, shows that the set can be placed in any position, and it remains in the required position as long as needed. This leaves the Service Man's hands both free, and it eliminates some of the gymnastics necessary in testing large, unwieldy sets.

The frame is made sufficiently large to accommodate any type of chassis, either the U type, box type or any other (Continued on page 44)



Fig. A  
New midget tubes—triode and screen-grid.



Fig. B  
The appearance of a French test unit.

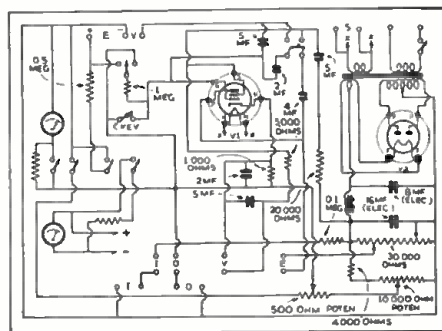

Fig. 2  
The circuit of the tester shown in Fig. B.

Fig. C  
A handy device for the service bench.

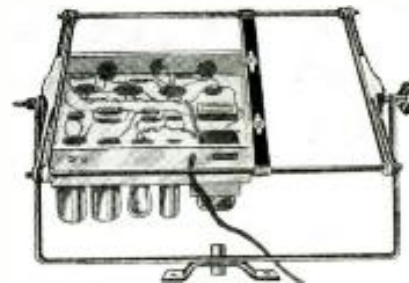
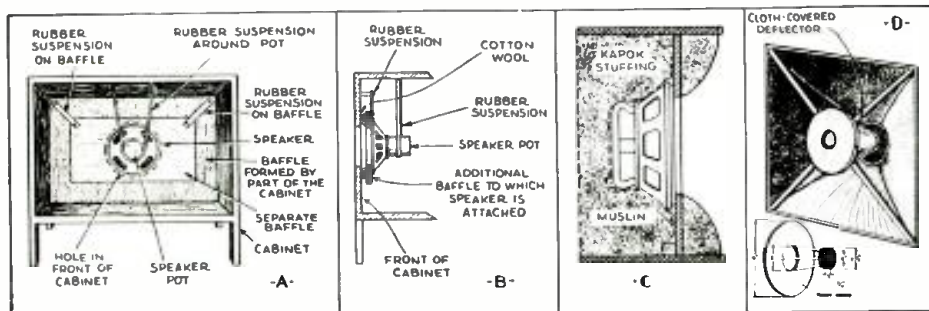

Fig.  
Two schemes for improving speaker frequency response are detailed here.



# THE LATEST RADIO EQUIPMENT



High-gain 4-tube amplifier. (728)



New V. T. Voltmeter. (729)



Improved "mike" stand. (730)



All-wave 4-tube set. (731)



Above, "porcelain" condenser. (732)

Below, power plant. (733)



## PORTABLE 12-WATT P.A. AMPLIFIER (728)

(Coast-to-Coast Radio Corp.)

THIS is an unusually low-priced and powerful amplifier capable of giving high-fidelity reproduction. It employs 1 type 53-tube as a high-gain, 2-stage preamplifier, 2-2A3's in a semi-fixed class A output stage, and 1-5Z3 or an 80 as a rectifier. Other features are a self-contained 2-channel "mixer-fader," built-in microphone current supply, "mike" current reading meter and voltage control. Any 200-ohm, double-button microphone, or 200 and 500 ohm phono pickup or line as well as a radio tuner may be coupled to the input circuit.

## A.C. OPERATED V.T. VOLT-METER (729)

(Electronic Appliance Co.)

A NEW A.C. operated vacuum tube voltmeter has been perfected combining laboratory accuracy with ruggedness of design, making it a valuable instrument for the Service Man. Especially useful for accurately aligning all-wave receivers, and to measure the gain in R.F., I.F. and A.F. circuits. An important feature is that the instrument cannot be damaged by any input circuit condition.

## COPY HOLDER FOR "MIKE" STANDS (730)

(Universal Microphone Co.)

STOCK model microphone stands will hereafter come equipped with a detachable light-weight copy holder for attaching announcer's notes, music and lecture sheets. This development in "mike" stands is the result of a survey among broadcasters and other extensive users of microphone stands.

## 4-TUBE ALL-WAVE KIT SET (731)

(Eagle Radio Co.)

ELECTRON-COUPLING is a distinctive feature of this 4-tube T.R.F. regenerative circuit, which is made in kit form. Extreme stability is another advantage of the circuit; also, the use of "E.C." gives a smooth regeneration control which has practically no detuning effect. The various wave-bands are obtained by means of plug-in coils. Tubes used: 1-58, tuned R.F.; 1-57, electron-coupled regenerative detector; 1-2A5, power amplifier; 1-80, rectifier.

## "PORCELAIN" CONDENSERS (732)

MICA condensers are now being housed in porcelain for pro-

tection against moisture and the elements. Extreme changes in temperature also have little effect on this moulded condenser. Ideally suited for automobile and airplane radio sets. Capacities range from 40 mmf. to .001-mf.

## PORTABLE 750-WATT POWER PLANT (733)

(Kato Engineering Co.)

THE newest model in portable A.C. lighting plants has an output of 750 W.; excellent for use at fairs, open-air camps, etc. The motive power is furnished by a direct-connected gas engine burning gasoline or kerosene. Can be made self-cranking simply by connecting to a starting battery. Remote starting control can be added. A new type of mounting eliminates the necessity of bolting down the plant.

## REPRODUCERS FOR CLASSROOMS (734)

(The Webster Co.)

A NEW series of magneto-dynamic 8-in., 3-watt reproducers has been designed for public institutions, such as schools, hospitals, etc., for use in individual rooms or wards. Frequency range: from 70 to 7500 cycles. Speaker housing is spot-welded steel, finished in aluminum crackle.

## DYNAMIC TUBE TESTER (735)

(Triumph Mfg. Co.)

THIS instrument affords dynamic mutual conductance test. Every type of tube may be tested, including the separate functions of diode and triode multi-purpose tubes. Provision is made for "neon" short and leakage tests. It is made in the striking two-color effect of black and yellow, to attract the attention of the customer.

## SOMETHING REALLY NEW IN SHORT-WAVE CONVERTERS (736)

(Rim Radio Mfg. Co.)

HERE is a short-wave converter that does not use a super-hetrodyne circuit. Instead of oscillating at a "difference" frequency, the oscillator section operates at the same frequency as some point in the broadcast band to which the regular set is tuned. In short, this 2-tube "converter" operates like an A.F. modulated service oscillator. Added features: headphone reception is separately available; a switch selects one of 4 bands; the detector section due to electron-coupling has uniform regeneration. Filaments are A.C. powered; plate voltage is secured from the associated broadcast receiver.

(Continued on page 41)

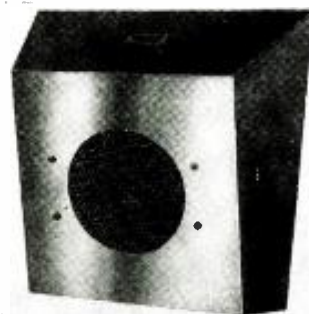

School-type speaker. (734)



Tests every type of tube. (735)



Non-superhet. converter. (736)



Above, Velocity-mike preamplifier. (737)

Below, speaker directional baffle. (738)

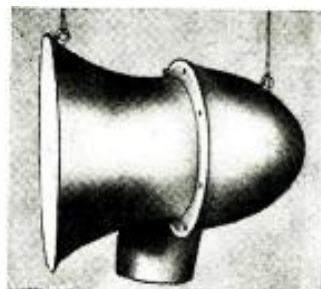

Name of manufacturer of any device will be sent on receipt of a self-addressed, stamped envelope. Kindly give (number) in description under picture.



# THE RADIO SERVICE BUSINESS

A summary of the difficulties encountered in running a service shop—and some advice.

WILHELM E. SCHRAGE

**R**ADIO service, an industry of little importance only a few years ago, has grown into a prominent position in the radio field. There are some experts who do not hesitate to announce that broadcasting would never have reached its present nationwide acknowledgment if the service industry—the emergency squad of the ether—had been an unknown institution. And also, that the radio industry would suffer considerably if all the radio Service Men were to quit their jobs at one time.

## THE RECOGNIZED RADIO DEVIL

During the past few years the radio industry has had the opportunity to perceive the valuable help of an efficient radio service, and their refusal to give the service industry the diagrams of their circuits, has entirely changed. Progressive manufacturers are now eager to furnish the Service Man with any desired information. The experience of past years has often shown that manufacturers, without the cooperation of the service industry, have had more sets returned than they liked, because of mistakes of design engineers, who looked upon the service industry as a sculptor does upon a quarry man. And if Mr. Cunningham of RCA Manufacturing Co., Inc. who used to be a regular Service Man in a similar field some 20 years ago, suggested the title *radio engineer* for a great many Service Men, it is pleasant appreciation for the splendid work which has been done by the radio service industry.

## LET FIGURES TALK

These, however, are only sentimental expressions without fact and figure. The facts and figures are rather more impressive than all the praise given by the radio industry. Careful estimations indicate that more than 40,000 radio Service Men are busy keeping broadcast receivers running smoothly, and the value of the yearly service cases executed exceeds 50 million dollars. This is a remarkable figure if we consider that the retail value of the 2.2 million table models distributed during 1934 was only 62.3 million dollars. (See Fig. 1A.)

The important position of the service industry as "buyer" may be shown by the fact that approximately 6 million dollars worth of replacement parts and accessories, and in addition, 1.3 million dollars worth of sets, analyzers, tube checkers and other measurement equipment (as indicated in Fig. 1B), have been sold in the past year to radio Service Men.

The statistics from the point of retailing are also imposing. The retail value of the tubes distributed by the service industry touches the borderline of 10 to 12 million dollars. (See

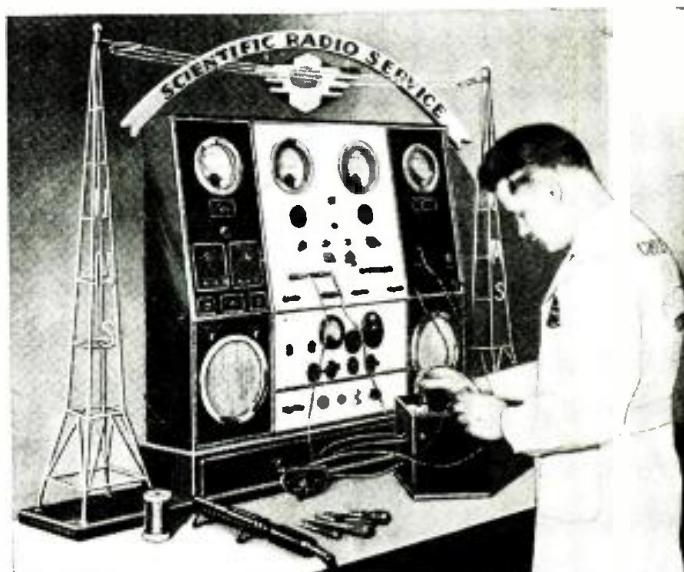

(Photo—United Motors Service)

A modern bench set up for servicing auto sets.

Fig. 1C.) The value of the dry and storage batteries sold by Service Men has been estimated at 4 million dollars; relative figures are given in Fig. 1D. About 30 million dollars worth of labor was utilized the past year by the radio industry, a source of labor absolutely unknown a few years ago. Compare the radio service labor figures with those for other classes of work listed in Fig. 1E.

## WHAT IS A SERVICE MAN?

Since radio service is one of comparatively few occupations in which anyone may engage, a great many unskilled adventurers have entered this profession. However, the exclusion of those who should be eliminated will not be accomplished as some Service Men might wish. They speak with pathos about "cleaning up the profession," really meaning a cutting out of nasty competitors. They like to build up heavy walls of examinations, but are eager to leave a backdoor open, to obtain their license without the despair of facing a probation commission. However no one will find the safe backdoor way; each of them will have to confess without any fake where he really belongs, and *the examination board will be the new type of radio receivers* of modern design, including such considerations as variable pass band, ingenious A.V.C. systems, complicated squelch circuits, and acoustical improvements of different kinds.

## KNOWLEDGE IS POWER

An impressive picture of what a real Service Man should know is given by the fact that in the last 12 years, about 10,000 receiver models have been put on the market by the American radio industry. Many of them are real bugaboos for the Service Man, because their manufacturers disappeared like snow in the spring sun, before the first 500 sets reached the radio dealer. No Service Manual tells their diagram, no replacement dealers supply the needed replacement parts. Sets of this kind are the real judges as to who is, and who is not a Service Man. Only the well trained and experienced man can handle this job; only he will satisfy the customer. The others have no future, since recommendations and old customers are the only fundamentals

(Continued on page 42)

Fig. 1  
Some statistics which support the author's summary of the service field. The magnitude of the service industry can be seen at a glance.

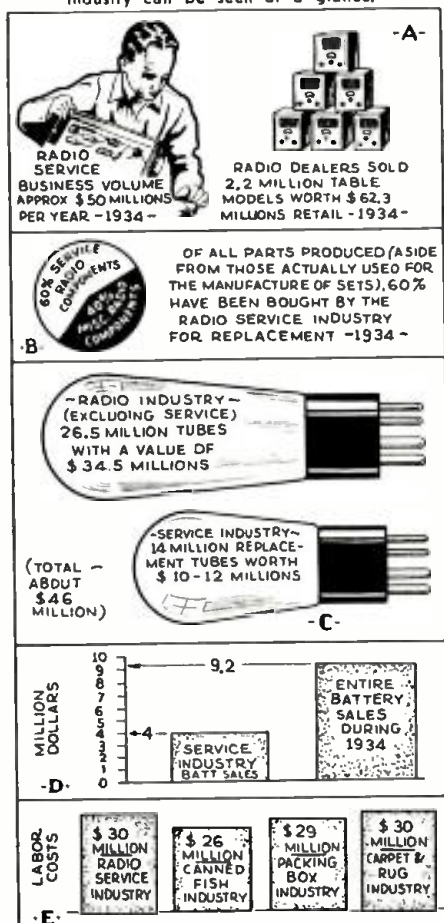

# ANNOUNCING—RADIO-CRAFT'S "IDEAL RADIO SERVICE SHOP" CONTEST—\$400 IN PRIZES!



Jack Grand



R. D. Washburne

THE JUDGES:  
F. L. Horman

A. A. Ghirardi

"Joining with RADIO-CRAFT staff and the judges in planning this contest, it is a great pleasure for me to offer knowledge gained in daily contact with hundreds of Service Men, and considerable personal experience in designing radio test equipment."

Signed JACK GRAND, DIRECTOR

Service Men—sit down right now and write a letter of 300 words or less describing the equipment you consider necessary for the Ideal Radio Service Shop.

WIN ONE OF THE VALUABLE AND USEFUL PRIZES OFFERED BY LEADING MANUFACTURERS!

It will cost you only the price of stationery and a stamp to enter this contest!

The purpose of the contest is to acquaint manufacturers with the apparatus requirements of the modern radio Service Man.

## WHO THE JUDGES ARE—

R. D. WASHBURN, Technical Editor.

FREDERICK L. HORMAN, Instructor; and Chairman, IRSM.

ALFRED A. GHIRARDI, Author.

Mr. Washburne is Technical Editor of RADIO-CRAFT, and in his official capacity has had occasion to analyze the characteristics and performance of every conceivable type of commercial and home-built test equipment.

Mr. Horman is Instructor-in-Charge, Service Division, RCA Institutes. As Chairman of the Institute of Radio Service Men, N.Y. Chapter, he is very active in Service Men's circles.

Mr. Ghirardi is well-known as the author of literature for the Service Man (including *Radio Physics Course* and—as co-author—*Radio Servicing Course*).

## WIN ONE OF THE FOLLOWING PRIZES:

**FIRST PRIZE**—RCA No. 9545 Portable Cathode-Ray Oscilloscope.....\$84.50 (Net)  
Complete with 6 tubes, including cathode-ray tube; and incorporating vertical and horizontal amplifiers, two power supplies, and saw-tooth timing-frequency oscillator.

**SECOND PRIZE**—Weston Model 663 Volt-Ohmmeter (and carrying case).....\$48.75 (Net)  
Single meter has full-scale deflection on 50 microA. Ranges: 0-10 megohms; 0-1,000 V., D.C.; and 0-100 ma., D.C.

**THIRD PRIZE**—Hickok Model OS 7 All-Wave Service Oscillator.....\$48.00 (Net)  
Incorporates a built-in output meter, reading from under 0.1 microV. to over 0.1-V. Fundamental frequency ranges, 85 kc. to 25 megacycles. A.F. output continuously variable from 0-1.0 kc. Undamped, or 50 per cent modulation at 400 cycles. Complete with 12A7 and 6F7, and power supply.

**FOURTH PRIZE**—Supreme Model 333 DeLuxe Set Analyzer; or (optionally), Supreme Model 85 Tube Checker (in either Counter or Portable model).....\$39.95 (Net)  
Set Analyzer utilizes a single meter, with scales as follows: 0-500 ma. and 1.25 A., D.C.; paper and electrolytic condenser capacities, 0-12.5 mf.; 0-1.250 V., A.C.; 0-1.250 V., D.C.; 0-2 megohms. Grid-shift test of tubes is provided; also, a tube base selector and

free-reference-point analysis chart. Tube Checker (optional award) incorporates a single. English-reading scale; neon leakage and short indicator.

**FIFTH PRIZE**—Clough-Brengle Model UC portable Vacuum Tube Voltmeter.....\$34.80 (Net)  
A precision 2-unit instrument. Ranges: 0-70 V., r.m.s.; 0-1,000 V., peak. The R.F. and A.F. sensitivity exceeds 28,000 ohms-per-volt. Supplied with a 6C6 and an 84 tube.

**SIXTH PRIZE**—Triplet No. 1200 Multimeter, and No. 1220 Free-Reference-Point Tester. (with No. 1202 2-section carrying case).....\$34.67 (Net)

Multimeter, two movements and scales. Ranges: 0-1,000 V., D.C. (2,000 ohms-per-volt); 0-1,000 V., A.C.; 0-250 mf.; 0-3 megohms. Free-Reference-Point Tester permits connecting the Multimeter into all parts of the circuit.

**SPECIAL PRIZE**—Six RADIO-CRAFT Consolidated Official Radio Service Manuals.....\$17.50 (each)

The Consolidated Manual contains over 1,000 pages of radio receiver diagrams, and includes the 1934 Official Radio Service Manual. These six manuals (valued at \$17.50 each) will be awarded to the 6 contestants submitting letters of prize-winning calibre who also are on the Subscription List of RADIO-CRAFT by August 15, 1935; thus, if each of the six winners of a main prize also are subscribers to RADIO-CRAFT, each one will receive in addition to his main prize a volume of the thousand-page Consolidated Official Radio Service Manual—otherwise, next-best letters will be selected, by the judges, from among subscriber-contestants, until the allotment of 6 manuals has been awarded.

(The estimated value in list prices for the above-mentioned prizes is around \$550. However, with discounts the net prices to dealers reduce this aggregate figure to about \$400; comparisons on the latter basis eliminated confusion.)  
(Continued on page 39)

**TRIPLET (6<sup>TH</sup> PRIZE)** WITH 2-SECTION CARRYING CASE - NET, \$13.00

**HICKOK (3<sup>RD</sup> PRIZE)** - NET, \$48.00

**SUPREME (4<sup>TH</sup> PRIZE)** - NET, \$39.95

**RCA (1<sup>ST</sup> PRIZE)** - NET, \$84.50

**CLOUGH-BRENGLE (5<sup>TH</sup> PRIZE)** NET, \$34.80

**TRIPLET (6<sup>TH</sup> PRIZE)** NET, \$21.67

**WESTON (2<sup>ND</sup> PRIZE)** NET, \$48.75

**SUPREME (4<sup>TH</sup> PRIZE)** - OPTIONAL - \$39.95



RADIO-CRAFT (CONSOLIDATED MANUAL) SPECIAL PRIZE \$17.50 (EACH)



# HOW TO MAKE A PERPETUAL ANALYZER PANEL

A complete analyzer panel for the shop which prevents obsolescence of the unit.

KARL FRANK

**T**HIS analyzer is of the "selective" type. The part that makes this analyzer different from any other is a unique switch, which permits cutting into any tube element circuit for current measurements with any range from 0-1 to 0-500 ma. A.C. or D.C. For voltage measurements, a selector-switch will connect the desired circuit and the voltage-range-switch makes it possible to get all D.C. ranges, which are in steps of 0-1, 0-1, 0-5, 0-10, 0-50, 0-100, 0-200, 0-500, and 0-1000 V.; and also the A.C. ranges which are in steps of 0-5, 0-10, 0-50, 0-100, 0-200, 0-500, and 0-1000 V. A single-pole triple-throw toggle switch permits voltage measurements between the various tube elements and cathode, filament, or ground. Tube tests can also be made by measuring the mutual conductance.

The measurements which can be taken from the tip jacks are as follows: current readings ranging from 0-1, 0-5, 0-10, 0-50, 0-100, and 0-500 ma., both A.C. and D.C.; voltage ranges as stated above; three ranges of direct reading resistance measurements; two output ranges, high and low; and two ranges of capacity measurements ranging from .025-5 mf. and from .5-10 mf. All readings are direct or simple multipliers must be used, except capacity measurements for which the meter has to be calibrated and the values determined by a graph.

The meter employed is an A.C.-D.C. type well suited for this purpose. Those who do not wish to make their own shunts and multipliers can easily acquire them specially made for this meter.

Switch No. 1, the current-selector switch, has two cir-

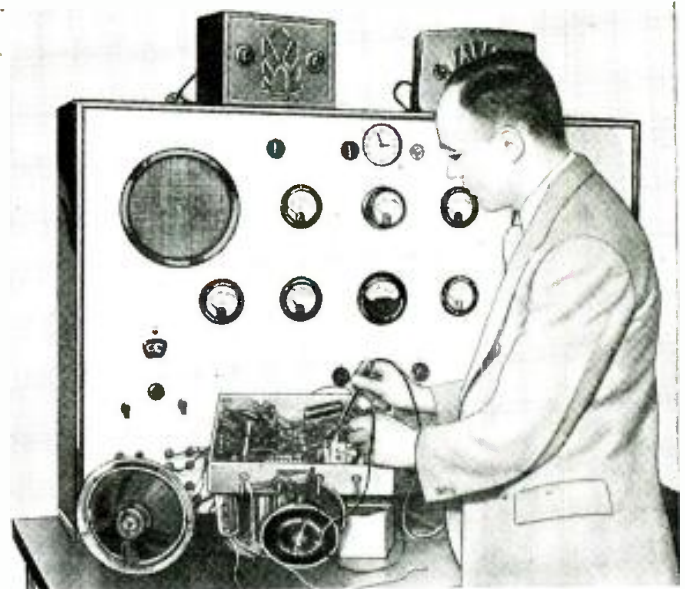

Fig. A—The analyzer panel in use on a set chassis.

cular decks. On the bottom deck, 8 stationary contacts are mounted. The upper deck has 8 flexible contacts, which are directly opposite the lower ones, and are pushed against the lower contacts by means of a spiral spring. A rotating arm consisting of a bakelite strip has copper leaves on each side which are insulated from one another. The edges of the arm are knife-like so that the contacts are forced apart when moved between them. When the rotating arm is moved between the contacts, the line is broken and the meter can be put into the circuit. The construction and functioning can readily be seen from the accompanying sketch and picture, Fig. 2A and Fig. B. All current readings from a tube circuit except the filament current can be made. One position is for the current tip jacks. One spare contact is provided in case an 8-prong tube should come into existence. (Note: the new metal tubes will require this extra contact.—Ed.)

Switch No. 2 is a ten-pole two-deck voltage selector and provision is made to measure the voltage between the plates of rectifier tubes. One position is also used for the voltage tip jacks.

Switch No. 3 is a ten-point voltage-range selector. For A.C. voltage measurements, 4,900 ohms of the multiplier resistor are shunted out with a toggle switch No. 8, which can be mechanically coupled to the A.C.-D.C. toggle-switch and so is taken care of automatically. An instrument fuse is inserted in the switch arm line, for meter protection.

Switch No. 4 is a two-deck 6-point type being the ohmmeter range selector and also the tube grid-test switch for either normal or control-grid. The 4.5 V. battery potential is put across a 300 ohm resistor, R 1, R 2, in series with the grid and thus the grid voltage is changed. The ohmmeter ranges are, 0-1,000, 0-10,000, 0-100,000 ohms.

Switch No. 5 is the D.C. range selector. In this case a series shunt is employed and toggle switch No. 11 is used for connecting it when currents of more than one ma. are measured. This switch (Continued on page 43)

Fig. 1  
The complete schematic circuit of the panel.

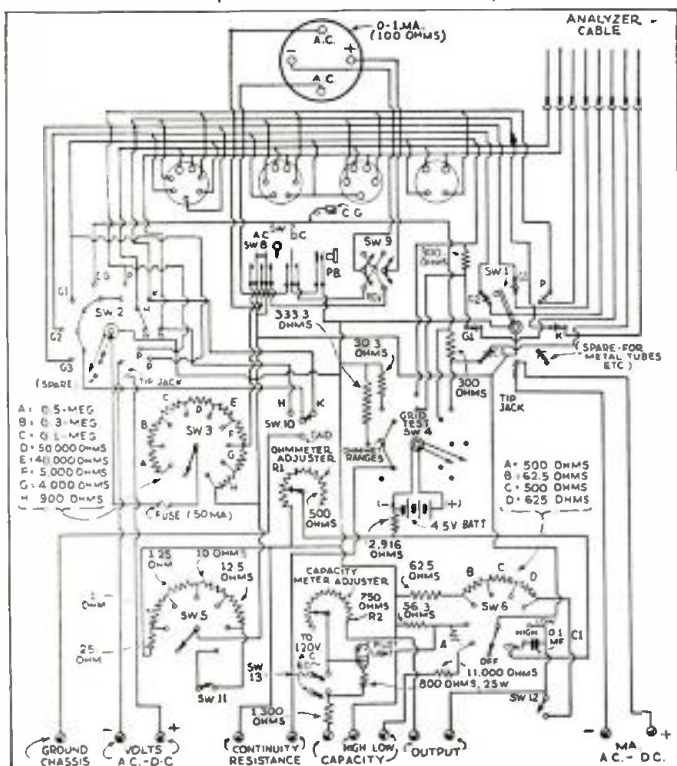

Fig. 2, right  
The analyzer switch, Sw.1, details showing how the contacts are separated by the arm—and the connections for the adapters used with the panel.

Fig. B, below  
The appearance of the analyzer switch, Sw.1, which is the "heart" of the complete unit.

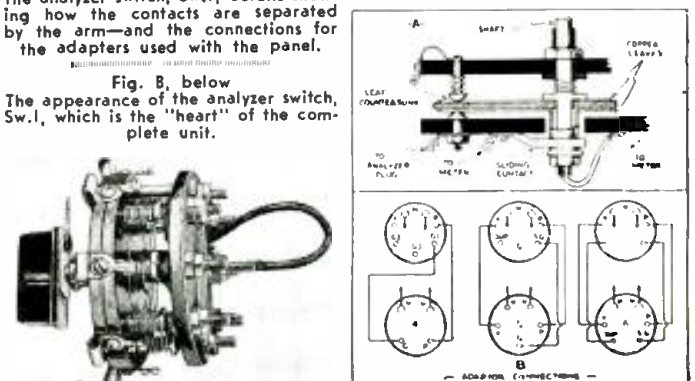



Fig. A. View of the completed "exciter."

**T**HIS dynamic speaker field supply was constructed to furnish excitation to a pair of Photophone speakers with the possible addition of a third; commercially-made units were much too expensive; and would only carry two speakers at the required load—and used two rectifiers to carry that load!

In its finished form this unit, illustrated in Fig. A, will furnish field excitation to three 1000-ohm speaker fields, or six 2,500-ohm fields; it is also adaptable to many odd values of field-coil resistance and current drain. In addition, when it is not performing its regular job it may be used as a source of rectified A.C. (needing only a filter to allow it to be used as a power supply for experimental equipment, or what-have-you).

In order to fulfill the requirement for economy the parts on hand were examined to see if any were suitable. This

## HOW TO MAKE A SPEAKER FIELD SUPPLY

Hundreds of radio men will be greatly interested in this practical construction article on a "field coil exciter."

EDWARD M. USHER

search brought to light a power transformer, delivering some 300 V. each side of the center-tap, as well as various filament voltages, and an 8 mf. electrolytic condenser. Using these two units as a starter the basic circuit was developed as in Fig. 1A. This necessitated the additional purchase of one 1,000-ohm resistor which amounted to some 29c. (This need only be of the 15-20 W. variety since it will only dissipate 10 W., as will be shown.)

The basic circuit of Fig. 1 consists merely of the transformer feeding into a full-wave rectifier circuit, the condenser for a filter, and the two fields and the resistor in series for the load. As the two fields each require a potential of 100 V. at 100 ma. for excitation, the two fields in series will provide a voltage drop of 200 V. when that current is flowing. Since, by Ohm's law, the total resistance to provide a voltage drop of 300 V. with 100 ma. current is 3,000 ohms, resistor R<sub>1</sub> becomes 1,000 ohms to provide the remaining drop of 100 V.

This circuit proved to be very satisfactory in use so it was decided to build the unit in such a way that one, two, or three fields could be accommodated by switching. Fig. 1B shows the circuit arrangement used for this. To place a field other than the first one in the circuit it is only necessary to open the

(Continued on page 47)

Fig. 1. Circuit of the field supply unit.

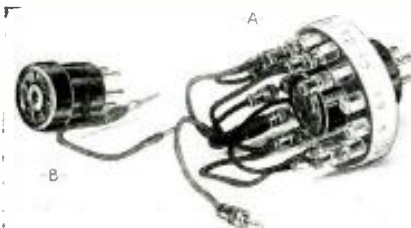
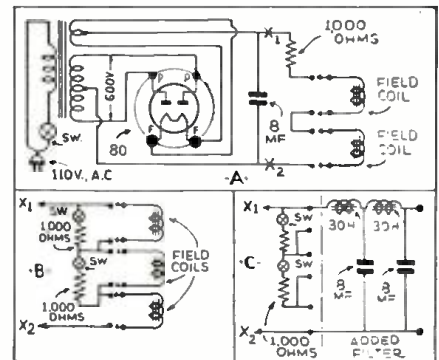

The new multi tube adapter.

**A**N EXTREMELY versatile tube-testing adapter has been developed by the writer to meet the demands of the new tube designs; as the appended list indicates, the possible combinations are practically limitless. The construction details follow.

The two disks shown in Figs. 1B and C must be the same in diameter, with edges as square and smooth as possible. This is important as otherwise the heavy paper shown in Fig. 1A cannot be glued on successfully. To drill the two disks, they must be bolted together tightly so they cannot slip out of place. This is done through the center holes with a bolt and two washers and a nut; clamp the disks in a vise and drill the 13 outer holes as outlined in the drawings of Figs. 1C and D. Take apart and drill the holes in the inner circle on the upper disk for the lugs to pass through and on the lower disk for the 4 wires to pass through into the 4-prong tube base. The hole in the center of the lower disk must be drilled or

## A MULTI-TUBE ADAPTER

Technicians long have wanted this sort of adapter, which supplies individual ones.

HERMIE D. VOGEL

reamed out to  $\frac{3}{8}$ -in. so as to fit over the long  $\frac{3}{8}$ -in. nut.

The 12 small jacks and the C.G.S. are put in the upper disk and the 7-prong socket put in the center with the lugs extending through the disk. The 1-in. bolt is passed through socket and disk and bolted together with the  $\frac{3}{8}$ -in. long nut. When this is completed, you are ready to connect the jack to the 7 lugs extending through the disk. These connections are shown in Fig. 1B.

Referring to Fig. 1B (G, P, H3 and H4) a  $3\frac{1}{2}$ -inch piece of insulated wire is soldered to each. These wires pass through the 4 holes so marked in Fig. 1D into the 4 pins of the 4-prong tube base which is shown in Fig. 1A. The tube base is fastened to the bottom of the lower disk as shown in Fig. 1A. A hole is drilled in the center of the 4 pins of tube base.

Referring to Fig. 1F, the bottom of

(Continued on page 48)

Circuit and construction details of the multi tube adapter and its accessories.

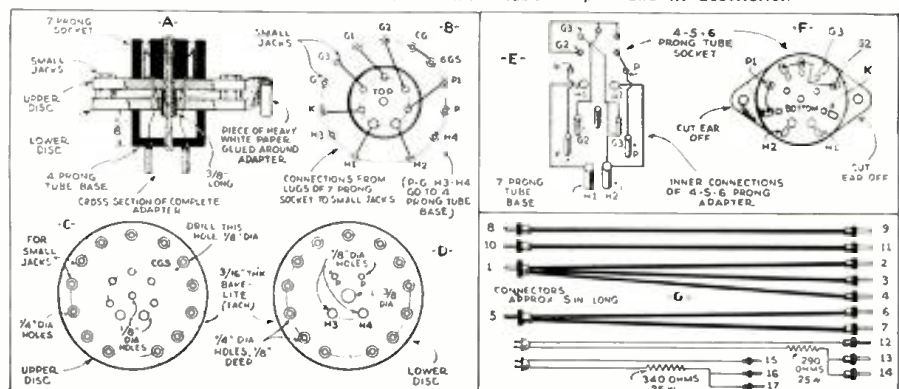



# SHORT-CUTS IN RADIO

FIRST PRIZE ..... \$10.00  
 SECOND PRIZE ..... 5.00  
 THIRD PRIZE ..... 5.00  
 Honorable Mention

EXPERIMENTERS: Three cash prizes will be awarded for time- and money-saving ideas. Honorable mention will be given for all other published items. Send in your best "kinks!"

## FIRST PRIZE—\$10.00

**INEXPENSIVE TIME-DELAY APPARATUS.** Built for less than three dollars; sold for ten and doing the work of apparatus worth fifty! The original purpose of this device was to automatically answer the door bell for a dentist and release the door catch downstairs when a client called. The wide-awake radio man, however, will readily appreciate its many other possibilities and applications.

Essentially, the unit consists of a set of old Kolster remote-control relays (rewired to suit), two 60-watt ten-cent flashers and two 60-watt electric bulbs. Its operation is extremely simple. When the doorbell, J, is pressed, relay A closes contacts G, which throws the first time-delay circuit (flasher E) across the 110-V. line. After 30 seconds relays B and C act in unison to open contacts G and close contacts H and I. These two contacts control the circuit to be time-delayed and relay D, which, after a second period of 30 seconds returns contacts H and I once more to normal.

L. FELDMAN

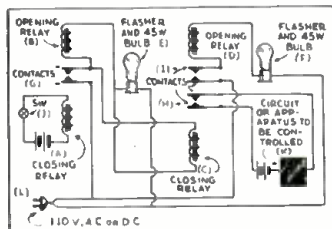
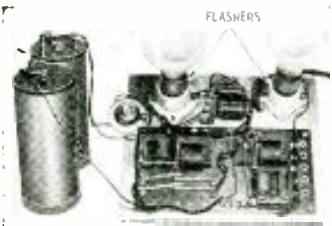

Figs. A and I. A time delay device.

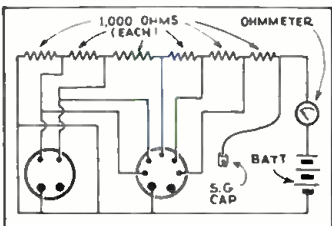

Fig. 2. A tube short-checker.

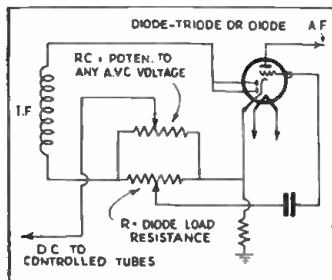

Fig. 3. A variable A.V.C. control.

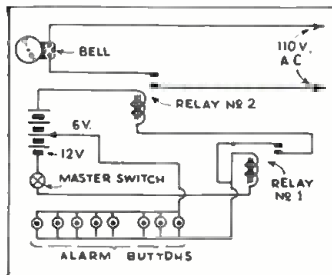
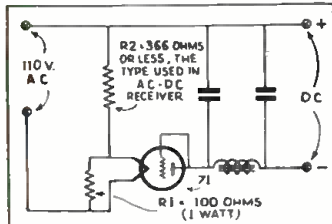

Fig. 4, above. Ford cut-outs for alarms.

Fig. 5, below. A rectifier service kink.



## SECOND PRIZE—\$5.00

**A TUBE SHORT CHECKER.** Many tube testers now in use make no provision for checking a tube for shorts between the various elements, and nearly every Service Man has experienced trouble from this.

The diagram, Fig. 2, will enable the Service Man to construct a simple short checker that will function with almost any type of voltmeter or ohmmeter. The reading for a good tube is always the same, regardless of the type or number of prongs. Tubes can be tested for leaks with the filament voltage applied. Any short in the elements will result in an incorrect reading. When using one of the low-priced ohmmeters to make up this outfit, resistors of 1000 ohms each are about right.

W. W. BISSELL

## THIRD PRIZE—\$5.00

**VARIABLE A.V.C. ACTION.** Here is a kink for varying the A.V.C. control voltage which is handy when hunting for DX stations, especially if the receiver does not have delayed A.V.C. This is also useful in cutting out noise when tuning. The potentiometer (Fig. 3) should have a high value (about 2 meg.) to prevent changing the diode load and cutting down the input to the first A.F. section.

HENRY WEIMAR

## HONORABLE MENTION

**FORD CUT-OUTS MAKE RELAYS FOR BURGLAR ALARMS.** Radio Service Men who are called upon to install burglar alarm systems can oftentimes get a used 110 V. A.C. telephone signal bell and with the addition of two old Ford cut-outs, make the required relays as shown in Fig. 4.

Remove the heavy outside windings from both cut-outs. For relay No. 2 be sure to remove the first layer, next to the core. This can be easily done by catching the outside turn, next to the core and pulling it out.

When any of the alarm buttons have once made contact, the bell will keep on ringing until the master switch is opened, as the two relays form a "locking" circuit.

J. THERIAULT

## HONORABLE MENTION

**AN IMPROVEMENT IN RECTIFIERS.** It is suggested that a type 71A tube be used in place of the type 37 often used as the rectifier in small A.C.-D.C. sets or in the power supplies of service oscillators, microphone preamplifiers etc.

The 71A has the advantage of lower cost and also there is less danger of overloading this tube. Resistor R1, in Fig. 5, is a 100 ohm unit used to increase the filament current to .3-A. so that the 6.3 volt tubes may be hooked in series with the 71A. The value of R2 depends on the number of tubes in series.

HAROLD L. KRAMER

## HONORABLE MENTION

**REPAIRING INTERMITTENT TUBES.** Every once in a while you will find a 27 or a 24 which flicks off and on, causing intermittent reception.

Whenever tubes of this kind are found, take your soldering iron and melt the solder out of the prongs. Then fill the prongs with some good make of soldering paste; run hot solder down into the prongs and then put a drop on the end. See Fig. 6.

JOHN D. HAYDEN JR.

## HONORABLE MENTION

**A S.P.-D.T. SWITCH FROM A PHONE JACK.** Service Men and experimenters who make their own test equipment will find this an easy way to make push-button switches.

Take an old phone jack and rearrange the prongs and insulators as shown in Fig. 7. Insert a button through the panel as shown and mount the jack in line with the button.

VERNON V. GOETZ

## HONORABLE MENTION

**TUBE TESTER FOR INTERMITTENT TUBES.** This tester is useful for tubes which operate intermittently at long intervals—twenty minutes to an hour.

Having encountered a number of tubes which acted normally when first turned on, but developed open filaments after operating for some time, I devised the unit shown in Fig. 8.

If the buzzing of the relay is bothersome, it can be stopped by slipping a piece of tape between the magnet and armature, but I

(Continued on page 44)

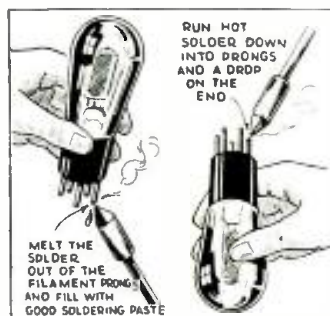

Fig. 6. A repair for intermittent tubes.

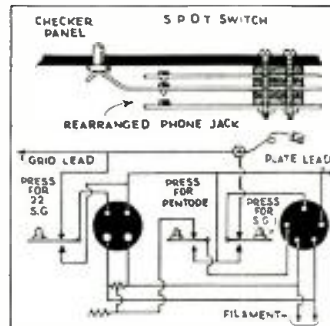

Fig. 7. Switches from phone jacks.

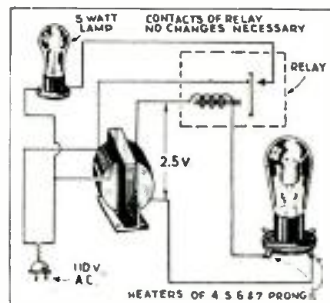

Fig. 8. A tube tester hint.

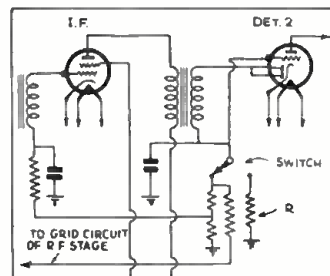

Fig. 9, above. Interference locator.

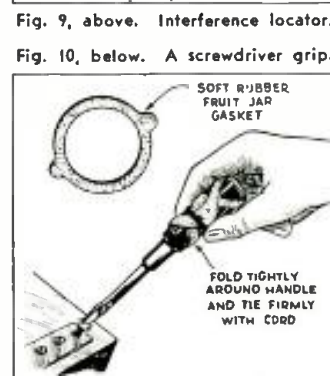

Fig. 10, below. A screwdriver grip.

# PRACTICAL METHODS OF SERVICING "NOISE"

PIETRO MUSCARI

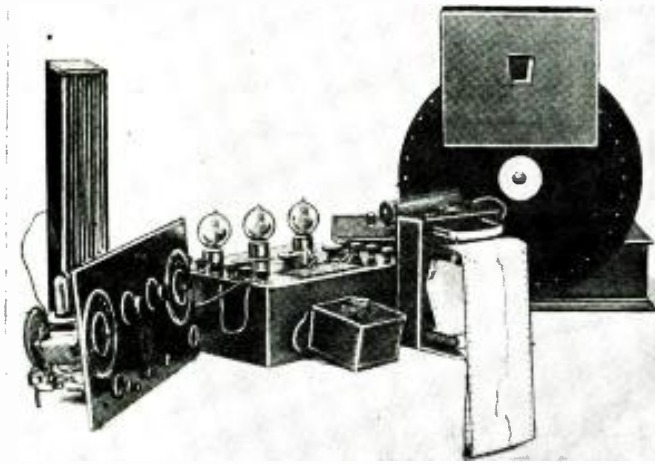

Fig. A. A sensitive superheterodyne, and delicate measuring apparatus, including an Esterline-Angus recording milliammeter are required for high-grade noise service.

FOR THE past ten years the writer has carried on a series of experiments and observations of the different phases of electrical interference, which may be divided into two classes: ethereal, and man-made.

Classification is necessary, so that one may distinguish the two different types of interference by real knowledge instead of guesswork. Each interference must be classified in accordance with (1) the path followed; (2) the intensity; and (3) the tone characteristics.

It is our intention to show that power companies cannot be blamed for most of the interference, but that the greater percentage comes directly from the use of electrical apparatus and appliances.

Different types of apparatus are used for running down the trouble, but the average Service Man does not have the equipment needed for this type of work, which makes it difficult for him to obtain results. Several systems are explained below; one of which will be found suitable for the needs and purse of any technician.

Even a sensitive superheterodyne is not sharp enough to show with certainty the direction from which the interference emanates. Also, when depending on auditory intensity measurements, the ear itself cannot be relied upon with any degree of exactness. This is because some ears are responsive to certain frequencies, but not to others.

The best method of computing this is by measuring the actual deflection of the output with a measured amount of input. In performing this, a graphic representation may be kept for each type of interference or noise noted.

Unless one intends to use a system in the same fashion as a radio compass station, a very sensitive receiver is not needed, and the straight regenerative type of receiver will answer the purpose very nicely. However, the ordinary receiving set may be equipped with an output transformer, and a good galvanometer, the deflection of which may be sensitive enough to measure the intensity of that particular signal at different intervals.

Never before has there been such a detailed and practical discussion of the interference problem. Beginners and experts, alike, can profit from this article.

## PART I

The writer has used a field intensity meter to measure the exact distribution of field intensity within the created area of interference. Several measurements taken in this manner, and plotted on a map give a high percentage of accuracy, when auditory methods might prove misleading.

While measuring the field intensity strength (when the detecting unit is within the field of the interference area) the closer the apparatus is brought to the interference, the greater will be the deflection on the output meter. By using a rotating carbonized cylinder, which is timed, a pencil may be placed on a stylus, and moved upon this cylinder. Thus, a curve of that particular interference is plotted, and we have a picture of the characteristic of that particular interval of interference.

A television disc, with a neon lamp, coupled (by means of an amplifier) to a receiving set, can also give a visual conception of the pattern of interference. This is another very convincing way of drawing a comparison between the different patterns of interference which a scanning disc may bring out.

In Figs. 1A and 1B are shown, pictorially and schematically, the two units working together; that is, the television disc and the rectified meter with a stylus to visualize and to give a graphic representation. At the same time that these two actions are going on, a third indication may be used. This is through the ear; the visualization, both graphic and pattern-like, is reinforced by auditory connecting bonds. Thus, through visual, graphic and auditory means, a pattern is formulated which the mind will always retain.

Many developments for a regular interference locator have been proposed. The writer's personal belief is that the field intensity meter similar to that used by the Bureau of Standards and other research organizations represents a most satisfactory piece of apparatus for the purpose, but the cost is so prohibitive as to bar it from most service organizations.

In Fig. 1C is a visual meter, which may be observed in operation. It consists of the following: a good 3-tube receiving set; a transformer with a turns ratio of 1:1; an 01-A tube; a 0-25 D.C. milliammeter; a switch; a resistance for varying the gain from the filament side of the transformer; a "C" battery for biasing the 01-A tube; a 6 V. battery for the filament of the 01-A tube; and a 90 V. battery for the plate supply.

The circuit is nothing more than a simple type of V.T. voltmeter. Across AB may be connected a pair of headphones, and through point AB a transformer primary may be inserted. There will be sufficient pickup to yield both an auditory and a visual means of picturing the typical classification of the interference.

(Continued on page 44)

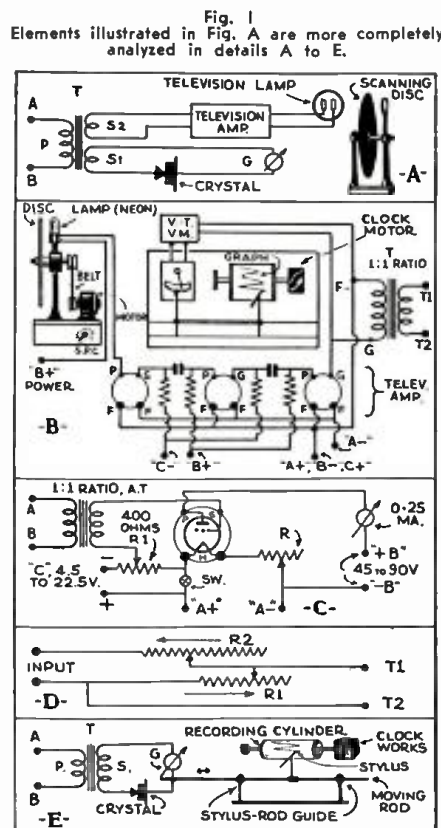



# MAKE THIS "SERVICE MAN'S COMPANION"

This instrument not only permits point-to-point analysis of voltage and current of any element of any tube, and resistance and capacity measurements, but also incorporates a Condenser Analyzer and Replacer, Resistor Replacer, and an A.C.-D.C. Voltage Supply.

**CANIO MAGGIO**

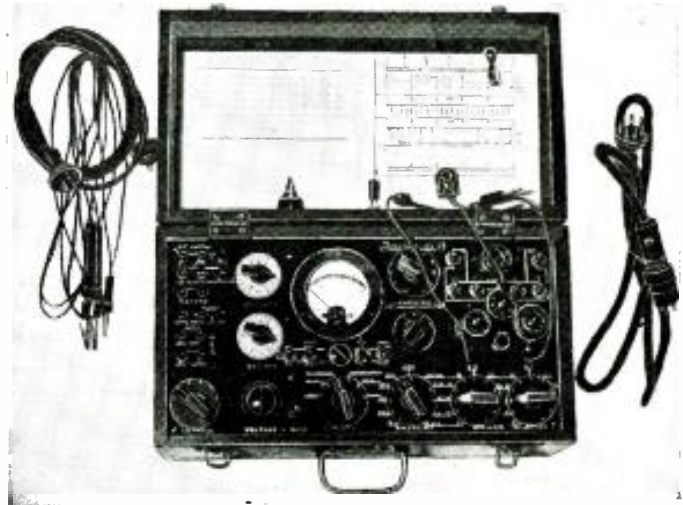

Fig. A. Front view of "Companion." Note scales in lid.

**T**HIS instrument comprises a complete point-to-point analyzer for voltage and current readings of any circuit and any point of the tube socket. The analyses are accomplished by means of two selectors of which one is positive (Sw.9) and the other negative (Sw.8); which have the same number of contacts. The positive is set at a supposed positive potential and the negative is rotated to the remaining circuits for potential difference. When testing for currents, set the selectors at the same positions, that is, if a plate-current reading is desired, set the negative to plate and the positive to plate and open the corresponding toggle.

When changing for different circuits close the plate toggle, set the two selectors, and open the corresponding circuit toggle, for other circuits desired. The push-button switch is a safety switch, which has to be used when taking current readings, that is, it should be open when changing from one circuit to the other and pressed for reading and locked if the current is to be observed. For voltage, resistance or any other tests the push-button can be locked. The different resistance ranges are also obtainable at the two circuit selectors

like the A.C.-D.C. mill-volts. The 0-30 ohms range is exceptionally valuable in adjusting gang condensers, comparing coils, filament circuits, voice coils and wherever a low resistance range is needed. The high ranges, 10 and 40 megohms, of course are used to test high resistances, the higher of which the Service Man will never meet in practical service, but which differentiates between values and obtains a fair deflection from .1 to 5 megs. without using a microscope.

The potential is obtained through a rectified high voltage supply. For the 10 meg. range, a potential of 150 V. is used and for the 40 meg. range, 600 V. The calibrations are the same as the .1-meg. range. In the 10 meg. range, multiply by 100 and in the 40 meg., multiply by 400.

(Continued on page 45)

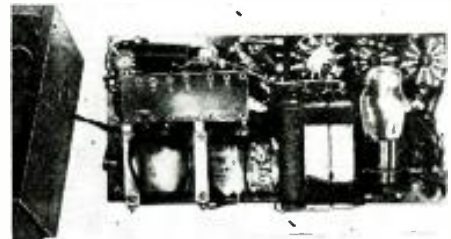

Fig. B. Interior arrangement of the components. Note the compact design that has been followed.

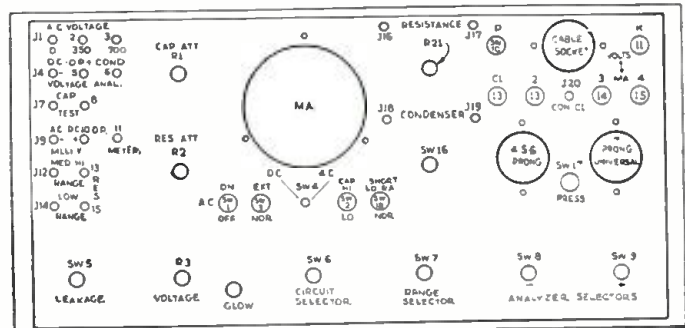
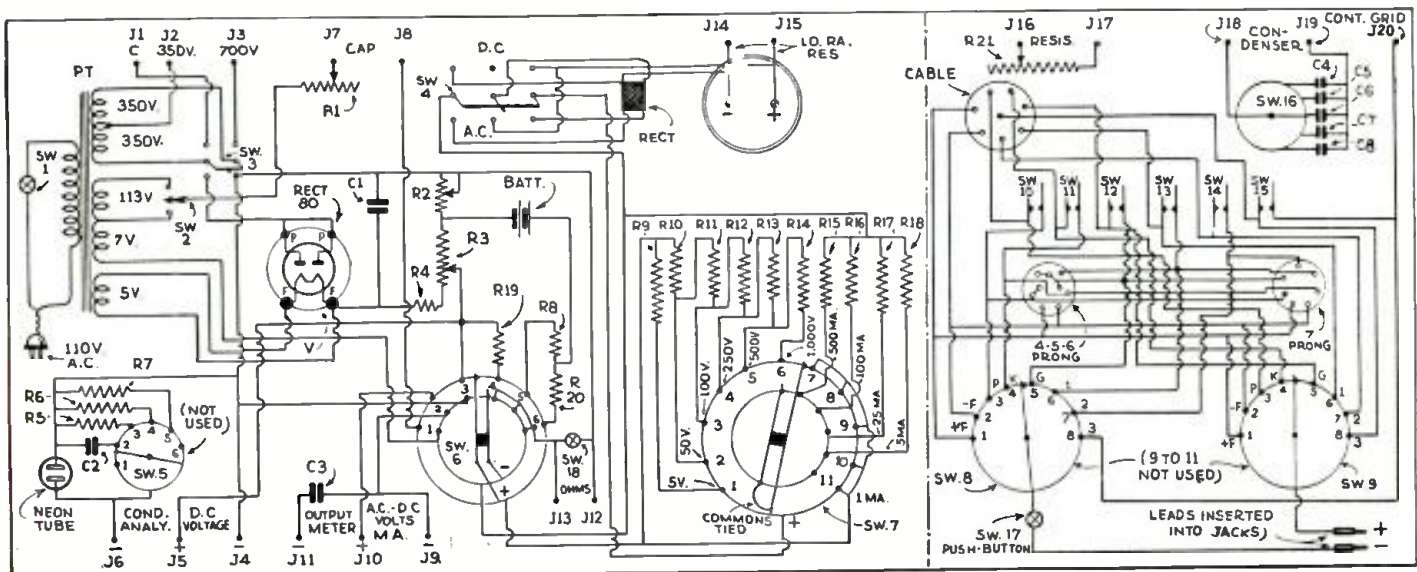

Fig. 2  
Drilling layout for the analyzer.

Fig. 1  
Circuit of the versatile "Service Man's Companion." (Foresighted constructors may wish to leave room for additional sockets designed for the new metal tubes.) Ranges: 50-1,000 v., D.C.; 0-500 ma.; 0-40 megs.; 250 mmf. to 2 mf.





# NEW DEVELOPMENTS IN CONDENSER CAPACITY AND LEAKAGE TESTERS

An invaluable unit which will speed up the job of locating defective paper and electrolytic condensers.

R. O. LUND\*

**M**OST radio Service Men will agree that the most vulnerable parts in a receiver are the filter and bypass condensers. This is not necessarily due to any defect in design or manufacture of these units, but more due to stringent limitations of size and cost by the receiver manufacturer. In addition, they are often operated at temperatures far above those considered safe, due to insufficient radiation of the heat generated by the tubes, etc., in the receiver.

A defective condenser may be open, shorted or have high leakage (low insulation resistance). An "open" condenser may be detected by a capacity bridge or by a capacity meter. A "shorted" condenser can sometimes be detected with a continuity or ohm-meter, but in many cases, the short is

not effective when the operating potential is not applied to the condenser. "High leakage" in a condenser can be determined with a meter or other indicating device in series with the condenser when a D.C. polarizing voltage is applied. It can also be measured by means of an insulation resistance tester, but the cost of such a device makes it unsuitable for service use. Leakage tests should be made at actual operating voltages to be indicative.

Many Service Men, in cases of suspected condenser trouble, admittedly resort to the substitution of new condensers for those under suspicion. The time alone involved in this method of servicing does not permit competition with Service Men equipped with proper instruments.

To meet this problem engineers, in cooperation with several large service organizations, worked out the condenser tester described in this article.

The unit performs two separate

functions; first, a Wheatstone bridge circuit is used for capacity measurement; and second, it contains a leakage and short indicator. A 1/4-W. neon light is used as the leakage indicator. In order to prevent A.C. ripple voltage from lighting the neon indicator, and also to isolate the condenser being measured from the source of polarizing voltage, a choke is placed in series with the neon lamp. (The voltage drop across the choke is so small that it may be neglected.)

The current for the capacity bridge is supplied (Continued on page 46)

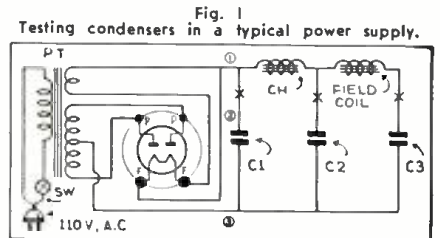

\*Sales Eng., Thorndarson Electric Mfg. Co.

# HOW TO OBTAIN HIGH FIDELITY

A frank discussion of the "high fidelity" situation and how existing sets and amplifiers can be improved.

LEON J. LITTMANN\*

**T**HE TIME has come when we should no longer be satisfied with mere radio reception or P.A. amplification, but rather, "High Fidelity" should become the motto of the day. It is hard to face the fact that only a minute fraction of all radio receivers and amplifiers in use and on sale today are of the "high fidelity" type. However it is a gratification to know that the average person is no longer

satisfied with music or speech reproduction which is not of the "high fidelity" type, once he has witnessed lifelike, realistic and distortion-free reproduction, void of all hum and hissing noises.

Several methods are available to approach, or to reach high fidelity reproduction. Among them are tone controls, equalizers, special transformers and improved component parts and accessories.



Fig. A. One of the frequency equalizers.

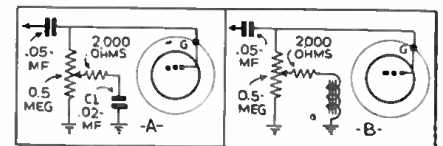
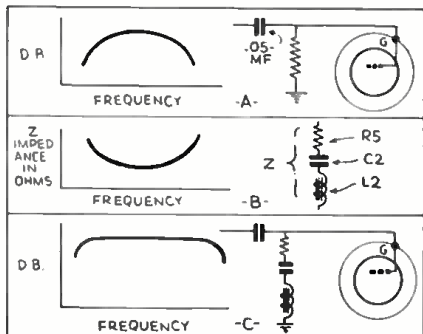

Fig. 1. High and low frequency attenuators.

\*Consultant, Alloy Transformer Co.

Fig. 4. Arbitrary curves of frequency response, plus impedance and effect of series filter.



## TONE CONTROLS

The early receivers and A.F. amplifiers were notably void of the low frequency range, due to the general inability of obtaining good A.F. transformers and associated parts at that time. Under these conditions the high frequency range, if reproduced at all, would invariably appear over accentuated, and full of shrillness. The remedy usually employed in such a case is shown in Fig. 1A. This high frequency tone control is particularly effective in resistance coupled stages, but is the (Continued on page 46)

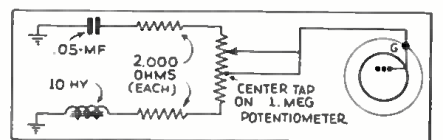
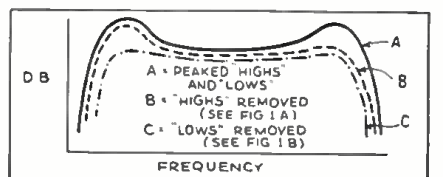

Fig. 2, above. High and low attenuators, combined; and Fig. 3, the effect on "peaked" frequency curve.





# MODERN SERVICE METHODS AND EQUIPMENT

Why testing equipment that was satisfactory a few years ago is inadequate for modern, complicated sets—is explained.

V. E. JENKINS\*

**W**HEN the radio receiver was a comparatively simple circuit using battery-operated tubes, the subject of servicing was not a difficult problem. The measurement of filament voltage, plate voltage and plate current was usually sufficient and this could be accomplished with a voltmeter, a milliammeter and possibly a continuity tester. Today, however, with very complicated circuits; the great variety of tubes; new features such as A.V.C., tone control and noise squelching circuits, many new parts have been added to the circuit in the way of resistors, and condensers—these parts and features now require something more than an ordinary voltmeter and a continuity tester with the result that the modern analyzing device has made its appearance.

Possibly if time were not a factor in the dealer's business, an ordinary indicating voltmeter and an ohmmeter and some sort of a continuity tester, would suffice for his service organization, but if he has progressed along

with radio these devices are not sufficient for a progressive service shop.

To follow the advance which has been made in testing equipment in general, it is interesting to compare modern analyzing devices with a set tester which was considered complete and entirely satisfactory six years ago.

## "RING IN THE NEW"

One of the first complete analyzers was the Weston Model 537 shown in Fig. A. This tester was made up of an A.C. voltmeter with three ranges, 0-4, 8, 150 V., and a D.C. combination volt-milliammeter with ranges of 0-8, 60, 300, 600 V., and two current ranges 30 and 150 ma.

Compare this instrument with the latest and most up-to-date type of analyzer, the model 665 in Fig. B. In this device 10 ranges with values up to 1,000 volts, both D.C. and A.C.; current ranges from 1 to 500 ma. D.C.; and resistance ranges up to 1,000,000 ohms are provided for the accomplishment of all phases of service work. (Continued on page 49)

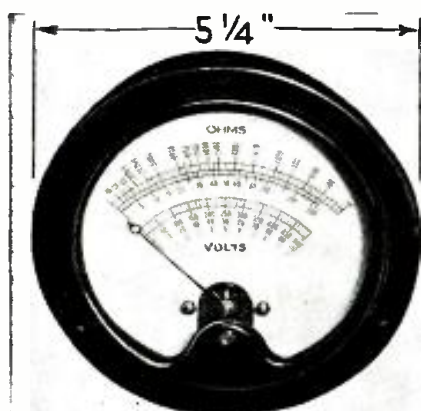

Fig. B, above; Fig. A, below. Test units—new (above) and old (below).



Fig. A, below. Test units—new (above) and old (below).

\*Radio Sales Div., Weston Elec. Inst. Corp.



GIANT-SCALE METER

The giant-scale meter, above, and the circuit of the tube and short checker, below.

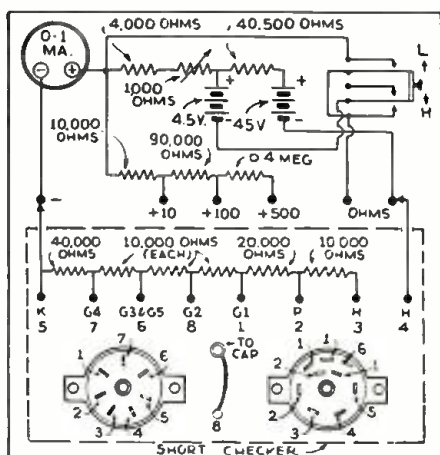

# A GIANT VOLT-OHMMETER FOR THE TEST BENCH

A combined test instrument and tube short checker which makes a practical service bench accessory in the shop. JACK DAHLSTROM\*

**B**IG, well-illuminated meters, which are constantly in use, lend prestige to the radio service shop patronized by "fix-it-while-you-wait" customers. A large, easy-to-read scale reduces possible errors in reading important values of resistance and voltage.

Simplification of scale ranges and a minimum number of plug connections combined with a tube short-checker feature the circuit employed with the newest type 5 1/4 in. Radolek-Triplett Volt-Ohmmeter.

Three voltage ranges, 0-10, 0-100, and 0-500, take care of practically all the requirements of D.C. potential measurements in modern receivers. If the addition of a 1,000 V. range is desired, the cost is only that of a .5-meg. resistor and a pin-jack.

The resistance measuring portion of the circuit is particularly interesting because of the low ohm scale, reading from left to right, as a result of shunting the 50-ohm meter movement with the resistance under test while full

current of one-milliamper is flowing. Two high ranges are provided using the top scale which is directly calibrated for a 4 1/2 V. battery. When used with a 45 V. battery all the top scale resistance values must have a cipher added—in other words multiplied by 10. This results in an ohmmeter range of 1/2-ohm to 1. meg. in conveniently read stages.

The inter-element tube short-checker utilizes the highest resistance range in a new circuit which instantly indicates an open circuit, a cathode-heater leakage as high as 1.9 megs., and any other inter-element short circuit in any four-, five-, six-, or seven-prong tube.

The mathematical analysis of the tube short-checker which brought about its development is interesting to students of Ohm's law. A total resistance of .1-meg. separates the cathode and heater terminals. The relatively low resistance of the tube's filament or heater which completes the circuit is not high enough to introduce an error in the reading on the high ohm scale of (Continued on page 49)

\*Tech. Dept., The Radolek Co.

## A TEST UNIT FOR SOUND SYSTEMS

At last, the sound field has been given test equipment distinctly its own, to facilitate service work.

HAROLD H. SHOTWELL\*



Fig. 1, below. A circuit break-down of the new analyzer for sound systems. (Only details A to D are discussed in Part I; details E, F and G will be described in Part II.)

**A** LARGE field, offering attractive opportunities to wide-awake, efficient, well equipped Service Men, has quietly but steadily grown up in the past few years entirely apart from the more widely advertised radio

\*Supreme Instruments Corp.

set field. This has come about through the increased use of sound equipment for several diversified purposes. These various uses include, among others, sound equipment in motion picture theatres, in auditoriums, stadiums, schools, hotels, restaurants, dance pavilions, etc.

It includes the following tests, which have been found to be adequate for testing all types of sound equipment.

- (1) Decibel ranges. -10 to +20 db. and +5 to +35 db. (referred to zero level of 6 milliwatts in a 500 ohm line).
- (2) Voltage Ranges, D.C. 0-5, 25, 125, 250, 500, and 1,250 V. (1,000 ohms per volt).
- (3) Voltage Ranges, A.C. 0-5, 25, 125, 250, 500, and 1,250 V. (1,000 ohms per volt).
- (4) Resistance Ranges. 0-500, 5,000, 50,000 ohms and 0-5, 5, and 50 megohms.
- (5) Capacity Ranges (low). 0.000125-0.00125 mf.; 0.00005-0.005 mf.; 0.00125-0.0125 mf.; 0.0005-0.05 mf.; 0.00125-0.125 mf.
- (6) Capacity Ranges (high). 0.005-0.5 mf.; 0.0125-1.25 mf.; 0.05-5 mf.; 0.125-12.5 mf.; 0.5-50 mf.
- (7) Current Ranges, D.C. 0-250 microamperes; 0-1.25, 5, 25, 125, 250, 500 ma.; and 0-1.25, 5, 12.5 A.

(Continued on page 49)

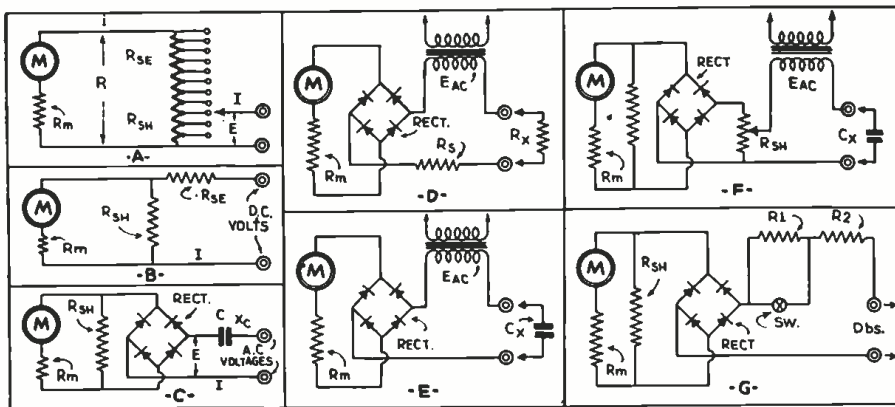

## BASIC SERVICE FUNCTIONS OF THE SIGNAL GENERATOR AND MULTI-METER

Every radio technician should make it his business to study and profit by this concise article.

J. J. McCARTHY\*

**A** SIGNAL generator and a multi-range meter form the foundation of a "service laboratory." Neglecting special-purpose instruments, such as condenser testers, vacuum-tube voltmeters, etc., you will find that perhaps 90 per cent of radio conditions can be investigated directly with the generator and meter. We do not minimize the usefulness of tube testers, cathode-ray equipment, etc., but we wish to emphasize the fact that these two instruments are the basis on which to build. While current, resistance and voltage measurements are essential in servicing any type of electrical apparatus, signal measurements are imperative in radio receiver repair.

The theory behind the signal generator method of testing is that the calibrated output of the generator supplies an indication of sensitivity, since a weak set will need a stronger input signal for a required output volume than a sensitive set.

Short-wave popularity has brought things to a head. Trimmer adjustment is critical in "all-wave" jobs and a nicety of setting is called for, so the oscillator, and more

particularly the signal generator, has received a "break." An investigation of R.F. and A.F. conditions, such as stage gain, for instance, clarifies any complaint picture. Then too, this sort of test can be made quickly without taking the components of the set apart.

It may be that the defect is finally located in a resistor, condenser or a coil, so we will continue to require voltage, resistance and current measurements, *but* we have the advantage of knowing where to look for the defective component by being shown which stage or function of the set is "out"; also in knowing *how much* the set is below standard or normal, overall.

For tests of this kind, a simple routine naturally suggests itself. First, a signal generator test, to determine the manner in which the set performs overall, then just where it seems to be operating least efficiently; second, a volt-ohm or current test in this area; third, correction of the improper condition; and, fourth, an overall measurement and thorough tune-up of the set as a complete amplifying system.

(Continued on page 50)

At A, the signal generator; B, the multi-meter.

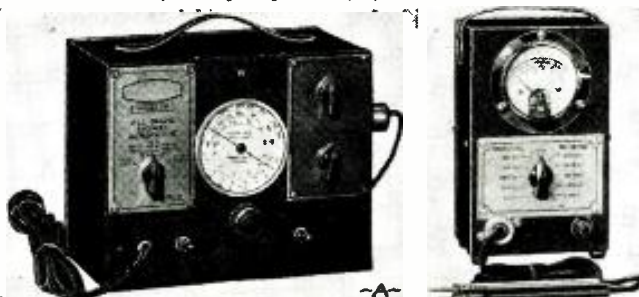

\*Triumph Mfg. Co.



# IMPORTANT FACTS ABOUT GROUP HEARING AIDS

Methods of mitigating defective hearing are described.

PAUL BOTTORFF\*

**A** NEW division in the Public Address field that promises to become very important is the installation of group hearing aids in churches, theatres and other public places for the benefit of those having impaired hearing.

Statistics show that over one per cent of the population would be potential users of such installations. Interest in the hard-of-hearing child in the public school is just beginning. Wisconsin is taking the lead in this field and have day schools in connection with their public schools for their children who have hearing impairments. Within the next few years every public school in the country will be equipped with an amplifier and phones for these children. When the children are furnished phones in the public school they will also become good theatre patrons.

A "group hearing aid" consists essentially of a microphone, or in special

cases in theatres a transformer connection to the main sound line; an amplifier of high quality; wiring; and the requisite number of outlet boxes and earphones.

The microphone used should have a low noise level. It should be located close to the amplifier in order to avoid difficulties encountered with long amplifier leads. In churches, it is desirable to locate the microphone some distance from the speaker in order to prevent wide variations of loudness due to changes in the position of the speaker.

In very small theatres where there is very little or no use of a stage, and



in large theatres in which special microphones are used to pick up programs from the stage to be rebroadcast through the regular "sound reinforcement" amplifier system, it is usual to transformer-couple an auxiliary amplifier system to the sound line, in order to raise the sound to the proper level for deaf-aid use. If a microphone is placed in the theatre especially for use in a deaf-aid system, it should be so located as to pick up programs both from the stage and the loudspeaker.

(Continued on page 49)

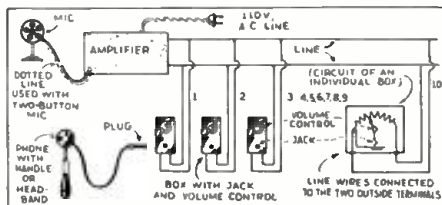

\*Engineer, Trimm Radio Mfg. Co.

# SERVICE AIDS FOR THE RADIO MAN

STANLEY B. VALIULIS\*

The experimenter is told how the "radio expert" saves time and money.

**T**HE writer intends to describe a few of the helpful "Service Aids"—their characteristics, and their uses—used by many expert radio men. It is very probable that many Service Men have never heard of these items, knowledge of which will save the technician time and money.

**Service Cement.** A very necessary item is "service cement" which is a flexible, and transparent cement specially prepared for work on dynamic speaker cones. It is fast drying, vibration proof and water proof. It's non-shrinking qualities make it the best cement to use on speaker cones. It is used in replacement work and in

\*General Cement Mfr. Co.

repair of old rattling or torn cones. A little cement around the spider or voice coil usually eliminates rattles due to loose parts. Loose seams on cones can be quickly cemented with this cement.

**Service Solvent.** This solution is used for loosening old cones that must be removed from the speaker for repairs without damage to the cone. It can also be used to thin the cement when necessary. Many Service Men have found this solvent a good cleaner for wire-wound volume controls, spring contacts on condensers, etc.

**Speaker Shims.** With speaker shims, the radio man can quickly and accurately center voice coils and cones on dynamic speakers.

The speaker shims shown in Fig. 1F are easy to work with and are permanent tools because they are made of flexible "swedish steel." The kit includes 16 shims in the following sizes: .0035, .006, .008 and .010-in. The .0035-in. shim, will take care of the smallest speakers. By a combination of sizes you can obtain shims as large as .0275-in.

**The Handy Pocket Tool Case.** The carrying of pocket tools has long been a problem to every Service Man. A screwdriver in one pocket, pliers in another, and cutters in still another often result in lost tools and worn and torn pockets. Now this problem has been

(Continued on page 48)

Fig. 1. Commercially available items for speeding radio work of all kinds.

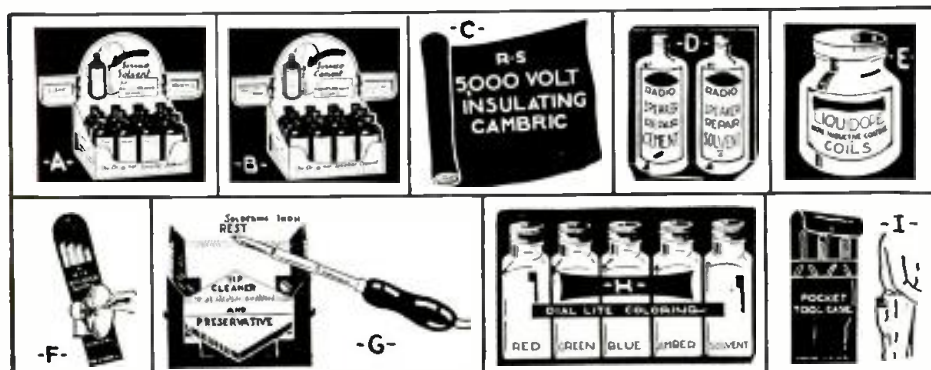



# DEAF-AID EQUIPMENT —A SERVICE MARKET

A continuation of the discussion, last month, of the possibilities of selling "deaf-aid" equipment to theatres, churches and other places where people gather. The technical considerations are covered in this second part.

R. M. GRAY\* PART II

**C**ONTINUING our discussion of last month, concerning the money-making possibilities lying dormant in the field of deaf-aid sales and service, we will now give the technician practical information that will enable him to immediately utilize his technical knowledge. This data is particularly timely in its appeal to the Service Men readers of the Service Number of Radio-Craft.

Components of one manufacture especially suitable for "hard-of-hear-

\*Sals. Eng'r., The Webster Co.

ing" application (an excellent example—see illustration—is an installation in the Granada Theatre, Chicago), include a high-grade, double-button carbon microphone mounted in a 14 in. desk stand. A standard, 25 ft. length of 3 conductor, shielded, microphone cable is included with this system and should suffice in most cases.

The amplifier especially designed for meeting the demands of installations of this type is an A.C. operated, 3-stage unit with an output of 10 W. and a gain of 72 db.

It uses one 2A6, two 53s, and an 82 rectifier. It has three inputs; high-impedance of 10,000 ohms and 5,000 ohms; and a low-impedance of 200 ohms (microphone input). It has a tapped low-impedance output for correct matching to the required number of earphone control boxes. There are individual volume controls on both the low-impedance input and the two high-

impedance inputs.

When used with a microphone, excellent pickup is available and the rated power output is obtained while talking in a normal tone of voice at a considerable distance from the microphone.

All component parts are contained in a well ventilated steel cabinet having a black crystalline finish. Power on-off switch and pilot light complete the controls on the panel. Tone control adjustment is also an incorporated feature to allow adaptation to the many varying conditions encountered in installing equipment of this kind.

A 2-conductor, heavy-duty, low-impedance and low-voltage special cable is used. It is not required to place this sort of cable in conduit (eliminating this expensive type of installation) it only being necessary to conceal it in some manner to give a neat appear- (Continued on page 50)

# NEW MONEY-MAKING POSSIBILITIES IN A PORTABLE P.A. DEMONSTRATOR

Alert Service Men will profit by the author's experience in the P.A. and recording field.

CHARLES R. SHAW\*

**T**HE DORMANT financial possibilities of legitimate radio sidelines have scarcely been realized by a great majority of Service Men who continue to adhere to fixed, rigid and limited routine of radio service in the strict sense of the word.

To list all of the "alive" sidelines which have become money-making by-products of radio development is beyond the scope of this article.

Principal among the popular fields offered to the aggressive Service Man for expansion of his service practice are

\*De-T. Engineer, Columbia Sound Co., Inc.

the sale, rental and maintenance of P.A., talking motion pictures, hearing aides, and home recording devices. The last named represents a most fertile field, for it requires but a small financial expenditure (well within the range of the average Service Man); and offers attractive profits on installation, sales and rentals to an almost unlimited field which can be easily contacted by the Service Man who makes up his mind to ambitiously push this profitable and easy-selling sideline.

In view of the fact that a reasonable degree of perfection has been attained in the making of playback records for permanently storing and (Continued on page 50)

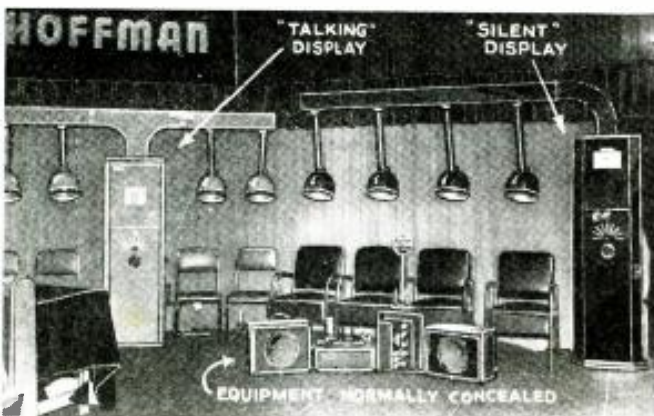

Left, A display set-up of P.A. equipment. The units shown in the foreground are usually concealed—they are the "voice" of the display. Below. The circuit of the amplifier described.

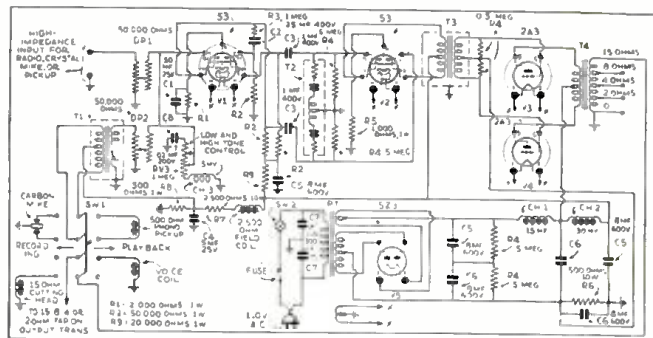



# CONSTRUCTION AND USE OF A BRIDGE-TYPE CONDENSER TESTER

Useful instrument for the Service Man—to speed up work.

F. L. SPRAYBERRY\*

**T**HIS is one method of testing a condenser that can absolutely be relied upon. A properly arranged circuit will not only test a condenser for complete shorts, but also for high resistance shorts, opens, and will also indicate the exact capacity of a condenser. The beauty of using such an arrangement is that all of the above tests may be made at one time. Most capacity indicating circuits are only

useful over a certain narrow band of values—not so with a bridge circuit—it will accurately indicate high, medium and low values of capacity.

It is regrettable that radio Service Men employ the bridge method of measuring so little. It really can be made their most useful measuring instrument. Perhaps one reason why this type of instrument is used so little is because charts and graphs have nearly always been necessary. Now, even these are not necessary. In our



The complete bridge type condenser test unit.

laboratory we have developed a special scale which enables the operator of a capacity bridge circuit to read directly the capacity value of a condenser and at the same time to determine whether an open, short or high resistance leak is present.

The circuit we have developed (Fig. 1) employs a standard balanced-bridge circuit. In this, A.C. voltage is balanced across a known capacity. It is made to equal the same value of voltage across the condenser being tested. This is accomplished by adjusting a variable resistance until there is no sound in the head-phones.

In testing electrolytic condensers, a similar procedure is followed, with the exception that (Continued on page 52)

\*Pat., F. L. Sprayberry, Inc.

Fig. 1. Circuit of the condenser bridge.

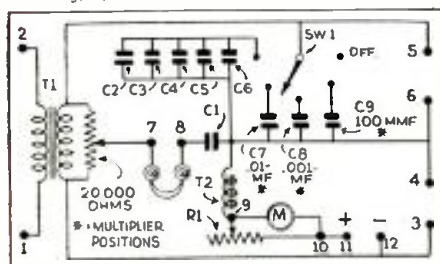

The interior of the unit is shown below. All parts are mounted on the panel.



# HOW TO USE THE SELECTIVE SIDEBAND SIGNAL GENERATOR IN RADIO SERVICE WORK

A specialized type of test oscillator for the service shop.

W. ROBERT DRESSER\*

**W**ITH the development of high-fidelity transmission and reception, it becomes the responsibility of the radio Service Man to maintain the high standards of receiver performance. The manufacturer has the problems of engineering and releasing a particular receiver model, but the burden of performance is always placed upon the Service Man, where a misunderstanding of the requirements of true fidelity can easily result in eradicating years of research and thousands of dollars worth of receiver design. Therefore, the Service Man, in understanding that the chief problem in radio reproduction is the recreation of audible frequencies, is always searching for new tools to permit his analysis of the radio-audio receiver characteristics as well as devices for the alignment and service analysis of everyday jobs. He has found that the conventional all-wave type of signal generator has been the most useful service unit for the analysis and alignment of the R.F. and I.F. sections of the receiver, but these units have not taken into account the A.F. response characteristics so necessary for a complete survey. He finds that he needs a small copy of the really up-to-date broadcast station for a satisfactory receiver analysis—a

big order indeed for the average Service Man, but certainly it would be a useful tool if it could be available.

The association of the A.F. oscillator with a signal generator is a step in the right direction in that it provides a full spectrum of modulated radio waves identical with those radiated by our radio station sources, but such a combination is undoubtedly too expensive to be practical for routine I.F. receiver alignment work; yet the radio Service Man realizes that I.F. alignment is so directly associated with the A.F. or modulated sideband response of the receiver that this alignment must be undertaken with extreme care. Simple I.F. peaking may be entirely satisfactory for the midget and automotive types of receiver, but for units intended for high calibre home entertainment available today, I.F. peaking must be considered from the standpoint of its effect upon the overall receiver output.

The conventional methods of I. F. alignment are usually intended to produce a maximum amount of controlled amplification for each stage employed, permitting no compromise in favor of quality considerations. Yet the Service Man realizes that certain practical compromises can be and must be made for fidelity alignments, but lacking the necessary tools he finds such (Continued on page 53)



Fig. A. The panel of the signal generator.

\*Chief Eng'r., The Audio-Tone Oscillator Co.



# A MODERN TUBE TESTER —A LETTER TO A TUBE ENGINEER

In this letter, the writer presents many facts of interest to the Service Man and radio dealer.

J. R. WILLIAMS\*

**R**EFERRING to the schematic circuit, Fig. 1, of the latest version of the test unit under discussion (and illustrated pictorially) it will be noted that we have maintained the same principle of test in our testers for 5 years. However, there has been constant, specialized work on refinement of tests and the rejection point of the various tubes. This 'rejection point' or bottom of the 'Good' section is supposed to interpret the point where a tube is no longer useful and should be replaced, or where a new tube is defective.

"We use a small hand-calibrated series-shunt resistor at the meter that eliminates all tolerances of the meter,

\*Mfrs. name upon request.

transformer, cable wiring, etc., to within 1/2 of 1 per cent. (Thus, identical performance is secured for each model.) Without this feature the device could not be used for grading tubes in various sections. Further, any tube tester using a rheostat (ballast) in series with the transformer primary is inconsistent at different line voltages. The higher-cost method of bringing out 20 primary taps for adjustment is more than compensated for by consistency.

"The circuit at first glance appears to be elementary, but the following break-down analysis will indicate that the values used are the factors that govern its efficiency.

"In the particular transformer used, there is an induced plate voltage with extreme limitation on possible current output, by use of very fine wire (No. 40). There is also one fixed voltage for grid bias. This fixed grid voltage (which is 'in phase' or positive) brings a normal tube to approximately the center of the straight part of the possible grid bias-plate current curve

(see insert A, in Fig. 1). The extreme limitation of possible plate current drain causes the tube under test to flatten its own curve (as indicated in insert B). This curve is automatically extended up and down according to the space-charge effect on different types by the use of this one fixed bias.

"The plate-current flow through the meter is governed and brought to the one indicating point by the use of shunts across the meter for all tubes of like worth, irrespective of plate-current value.

"The effect on readings, or the curve, by tubes having low emission; or various plate impedances, with resulting plate current, is evenly graduated by the one fixed bias.

"The conventional shifting of bias for mutual conductance reading is no more effective than this use of the one fixed bias with automatic plate-current drop due to supply limitation from the transformer; time after time, this principle has been proven to closely follow a laboratory mutual conductance test. (Continued on page 54)

## HOW TO MAKE A D.C. TO A.C. METER CONVERTER UNIT

Many Service Men have D.C. test units or instruments which are limited in their application because they are incapable of testing any A.C. circuits. This adapter will permit such tests.

MILTON J. REINER\*

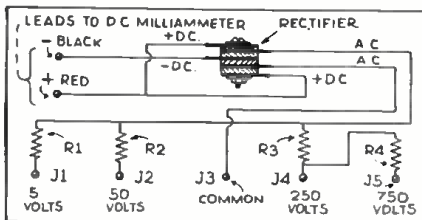

The circuit of the adapter (above) and its appearance, ready to use (below).



**E**VERY radio mechanic owns a D.C. instrument in one form or another. It may be an 0-1 ma. milliammeter which he has built into a general test instrument by adding shunts, multipliers, switches and jacks; or it may be a factory-built testing device having a D.C. milliammeter as its fundamental unit. However, the chances are that there are no provisions for measuring A.C. voltages—particularly at both power and audio frequencies, such as confront the radio Service Man and experimenter.

An ideal solution for this difficulty is an A.C.-D.C. "converter unit" (see photograph) made up as follows: The "heart" of this gadget, as shown in the schematic circuit, is the copper-oxide rectifier. This unit consists of a series of copper discs having on their surfaces a coating of copper-oxide. The electrical resistance of these discs depends chiefly upon the polarity of the voltage applied to the discs—is considerably higher for one direction than for the other.

\*Radio City Products Co.

This results in a rectifier action. If the rectifier now is connected to the meter in the conventional bridge circuit, full-wave rectification takes place so that when an A.C. voltage is applied to the input of the bridge, a pulsating direct current will flow through the meter which will indicate the average D.C. value.

Therefore a calibrated A.C. voltmeter can be made very simply, by inserting non-inductive multipliers of suitable value in the A.C. input line to the bridge. Copper-oxide rectifiers are rather delicate instruments and must be handled with extreme care. They can easily be ruined by passing too much current through them or by subjecting them to heat or physical shock.

The calibration of the rectifier depends to a great extent upon the pressure at which the discs are clamped together; any slight change in this pressure probably will throw out the readings considerably. Therefore do not by any means tamper with the clamping (Continued on page 55)



# HOW TO MAKE AN A.C.-D.C. 1-TUBE "DEAF AID"

Deaf-aid equipment is finding so many applications in theatres, churches and other places where people gather that the Service Man will do well to investigate this "source of profit."

J. B. CARTER

PROBABLY every hard-of-hearing person who owns a battery-operated electrical hearing aid has at one time or another desired a similar device that could be operated from the power line, thus eliminating bothersome batteries.

After a careful study of the equipment requirements for such service, the author set about designing a simple 1-tube amplifier which would enable even very deaf people to hear just as distinctly as those possessed with the finest hearing. The outcome of this study is presented here in the form of a descriptive article enabling anyone versed



in the rudiments of radio to easily duplicate the construction of this unit. For those not skilled in radio construction, it is suggested that the job be given to a local Service Man.

Fundamentally the device is a 1-tube A.F. amplifier utilizing the type 12A7 dual-purpose tube in conjunction with a microphone and headphone. The refinements of the completed design warrant the following detailed description.

Inasmuch as this unit will be used only indoors—often in the manner shown in the heading illustration—there is no pressing need for portability. Nevertheless, the unit described is quite compact. May we offer a suggestion—use the specified parts for best results, inasmuch as each one has been selected for a specific reason. (There is to (Continued on page 55)

Right, The circuit of the deaf-aid.  
Below, The interior of the unit.

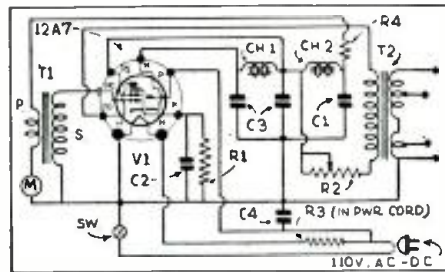
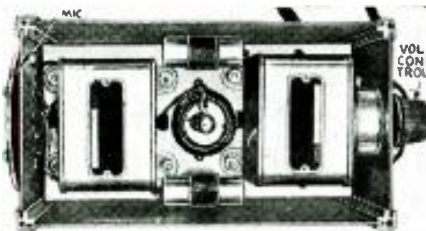

# VALUABLE "DECIBEL" DATA

The development of high-fidelity receivers and amplifiers has increased the use of the decibel system of sound measurement to a point where every Service Man must know how to use it. The author works out actual examples.

I. A. MITCHELL\*

DU E to the fact that the human ear is sensitive to intensities of sound in a logarithmic ratio, electrical measurements in the communications fields can be easily compared through the use of a measuring system whose integral values change in a logarithmic ratio. This system uses the "decibel" as a unit of energy comparison, the decibel being readily defined by the formula

$$\text{db. (gain or loss)} = 10 \times \log_{10} \frac{\text{watts output}}{\text{watts input}}$$

To set up a standard of electrical energy comparison, the use of the decibel has been based on a reference level of 0db. at a power level of .006-watt. In other words, energy levels greater than .006-watt are + db. compared to reference level; and energy levels less than .006-watt are - db. compared to reference level.

The chart shown as Fig. 1 indicates power level in watts against db. as compared to .006-watt reference level. The db. equivalent of any specific value of audio power can be immediately determined. This chart can also be used for determining db. gain or loss if the two powers are known. The db. equivalent of these powers can immediately be located on the chart. Subtracting these db. equivalents (algebraically) we obtain the gain or loss in db. For example, let us consider an amplifier which requires 1 volt at 500 ohms input to drive the output to 12 watts. The power

$$\text{input equals } \frac{E^2}{R} \text{ or } \frac{1}{500} = .002\text{-watt.}$$

\*Chief Eng'r., United Trans. Corp.

The db. equivalents for input and output powers are then seen to be approximately - 5 db. and + 33 db. respectively. The overall gain is then 33 - (-5) or a total of 38 db.

Table I is intended for the conversion of power or voltage ratios to db. If voltage ratios are used, it is necessary that the same impedance apply to both voltage measurements. The lesser value of power or voltage should be taken as the numerator of the ratio so that the ratio itself will be less than unity. Whether the db. value obtained is a gain or loss is naturally governed by whether the output power or voltage is greater than the input, or less. Current ratios are the same as voltage ratios. If the loss or gain is greater than 20 db., the

(Continued on page 56)

Fig. 2  
Curves A, B, and C represent the power requirements for different external noise levels.

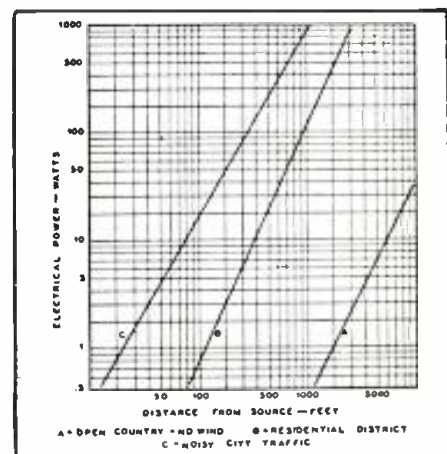



## THE NEED FOR A "TUBE ANALYZER"

Inter-element and "hot" cathode leakage, and a "tube merit" rating are incorporated in a new service instrument.

H. M. KLOTZ\*

**T**IME was, when a "tube checker" that would accurately differentiate between plate-current readings, could be classed as a fine test unit. Today, what with over a hundred different types of tubes—multi-purpose and otherwise—something more comprehensive in test facilities is essential. A discussion of a commercial laboratory development in test apparatus to meet modern needs discloses provisions for three fundamental test conditions.

**Test No. 1—Internal Resistance Test Between Elements.** Not only does this test show leakage between one element and any other element, but between any elements. This is of great importance in present day tubes involving multi-electrodes which are usually operated at varying voltages. It can be readily

\*Mfrs. name upon request.

seen from this fact that any leakage between electrodes within the tube would cause difficulty in the operation of the radio receiver which could not be checked otherwise. This leakage will not show up as a bad tube in ordinary conductance tests.

**Test No. 2—"Hot" Cathode Leakage Test.** This test is of the greatest importance and we firmly believe that any tube checker which does not provide for this test is equally as obsolete as a tube checker which tests only up to the 47 type tube. Cathode leakage, in tubes used in the present day receiver involving A.V.C., Q.A.V.C., frequency converters and output pentodes, cause in a good many cases, fading, noise, and either permanent or intermittent distortion. Furthermore, it is important that this test be made while the tube is heated and it is for this reason that we have provided this Hot Cathode Leakage test in addition to the "Neon" leakage test. In our opinion we cannot

urge the necessity of this test too strongly.

**Test No. 3—"Tube Merit" Test.** Assuming that the basis of all tube operation depends upon the electron activity within the tube, our engineers have designed a tube analyzer which directly measures this electron activity. (Hence the trade name, Electronometer.) In other words, if the electron activity of the tube is below normal, then the tube, of necessity, must be below normal regardless of other conditions that may exist in it. Furthermore, in our design we have incorporated the fact that every element within the tube reflects its connection with electron activity directly on the meter scale. That is, if an element is open or badly out of adjustment this condition would be noted on the overall performance of the tube. This method of test is directly in accord with the engineers of leading tube manufacturers and is particularly ap-

(Continued on page 55)

## RADIO RECEIVER CONNECTIONS FOR "CATHODE-RAY ALIGNMENT"

The average Service Man's head is fairly awl with cathode-ray technical terms. The present practical article, then, will be a welcome one, inasmuch as it clarifies the important question—"how is it connected?"

ALFRED A. GHIRARDI\*

**T**HERE are no fixed rules regarding the connection of the cathode-ray oscilloscope to the receiver which is being aligned. Every oscilloscope manufacturer supplies detailed instructions for its use, which should be followed. The following points, however, should be kept in mind, whenever such instructions are not available. The best way to connect the cathode-ray oscilloscope to the receiver output depends on whether the receiver uses (1) diode, (2) biased, or (3) grid-leak detection.

If a diode second-detector is employed, the output should be taken off across the volume control alone, or across both the volume control and the A.V.C. resistor, if this connection is convenient. (See Fig. 1A.) Otherwise, it is satisfactory to take the output voltage off between the grid of the tube following the diode circuit, and ground. This output is fed to the internal amplifier in the cathode-ray oscilloscope and the amplifier, in turn, feeds the proper pair of deflecting plates in the cathode-ray tube.

When the second-detector is a biased triode, tetrode or

pentode, resistance-coupled to the first A.F. stage, the output signal may be taken off between the plate of the tube and ground. (See Fig. 1B.) If it is impossible to take off one connection from ground, a 60-cycle gradient may be built up between the oscilloscope and the receiver itself. This will deform the image on the cathode-ray screen. This can be eliminated by connecting the cathode of the second-detector to the "ground" side of the oscilloscope amplifier, or to the grounded plate of the pair of deflector plates.

In the case of a triode, tetrode, or pentode, transformer or impedance-coupled to the first A.F. stage, connect a resistor of approximately 20,000 ohms in series with the

plate of the tube and bypass the inductance in the plate circuit by a 1.0 mf. or larger condenser. (See Fig. 1C and D.) This changes the impedance of the plate circuit to resistance rather than inductive reactance. The A.F. output voltage should then be taken off between the plate of the tube and ground, in order to take it off this resistor.

When the detector is of the grid-leak type, it is usually best to take the output out

(Continued on page 55)

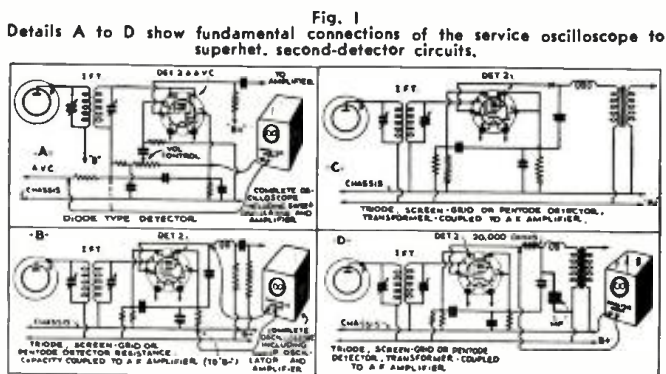

\*Radio Technical Pub. Co.



# A BEGINNER'S SHORT-WAVE CONVERTER

A well-designed converter for receiving S.-W. signals.

HUBERT L. SHORTT\*

IN THE design of this converter, the short-comings of other converters were considered and every effort was made to produce one which would include the advantages of previous converters, without any of their defects.

A few of the features are:

1. Full short-wave coverage, from 200 down to 13 meters.
2. Reliable band switching.
3. Self-powered. This is important. The broadcast receiver certainly should not be expected to supply juice for three or four extra tubes; most low priced B.C. sets just manage to stagger along by themselves! Good rectifying and filtering is essential to keep hum level down.
4. Have adjustable I.F. coupling stage between mixer

tube and receiver input, for the sake of selectivity and proper matching.

5. Strong mechanical construction.

Four tubes are used. The mixer or first detector V1 is a 6C6, the local oscillator V2, a 76. Four pairs of fixed coils, with suitable trimmer condensers, are controlled by a five-position switch, giving comfortably spread out bands as follows: 1.5 to 3.2 mcs., 3 to 6.8 mcs., 5.7 to 12.5 mcs., and 11.5 to 25 mcs. In the fifth position the switch connects the aerial directly to the broadcast receiver. The mixer-input circuit, is tuned by variable condenser C, the oscillator by C2; both part of the same double unit.

The use of a 6C6 as mixer tube permits a novel coupling idea to be employed between V1 and V2. The locally generated oscillations from V2 are tapped off the grid and lead directly to the suppressor grid of V1. This gives positive "mixing" electronically, without the bother or uncertainty of capacitive or inductive coupling.

The condenser C1 and C2 and their respective coils are adjusted to give a 540 kc. heterodyne signal. This feeds through the amplifier stage consisting of a 540 kc. transformer T1 and tube V3, which is a 6D6. The plate of the

(Continued on page 58)



The appearance of the S.-W. converter.

The circuit of the complete unit with the 540 kc. I.F.

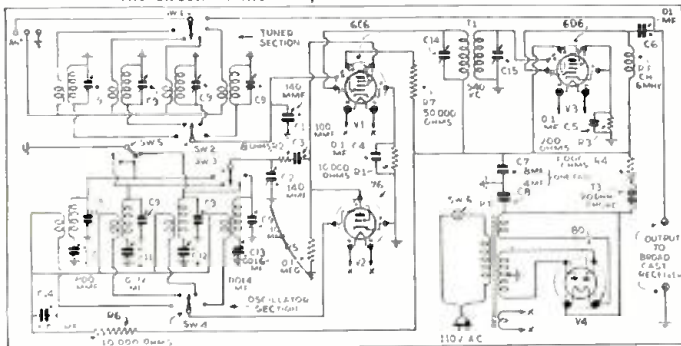

# HOW TO MAKE A NOVEL 1-TUBE BATTERY SET

An interesting all-wave set for experimenter and tyro.

J. S. CAULFIELD

FOR the experimenter who wants a really intriguing circuit with which to experiment, but who does not want to invest a lot of money in tubes and apparatus, the writer submits the circuit shown in Fig. 1, and the set design illustrated in the photographs.

This diagram is a fundamental arrangement of the "dynatron" principle

of operation discussed at length in the articles entitled "Facts About Dynatron Operation," which appeared in the March and April 1934 issues of RADIO-CRAFT; the circuit is an adaptation of Mr. Chorpennig's "1-Tube Dynatron Electric Set" described on page 419 of the January, 1933 issue.

As these articles on dynatron operation indicate, the actions that take place in a circuit of this type are quite involved. In general, however, it may be stated that the dynatron effect is secured in a tetrode (screen-grid) circuit when the plate potential is reduced to only about 40 per cent of the screen-grid voltage. When a certain critical point is reached in the relative values of these two voltages "secondary emission" from the plate takes place, whereupon true dynatron operation results.

The foremost indication that the dynatron effect is being secured usually is the presence of a high-pitch whistle, and distortion of the station program, when manipulating resistor R2. With regeneration control R1 adjusted for maximum regeneration, the idea is to

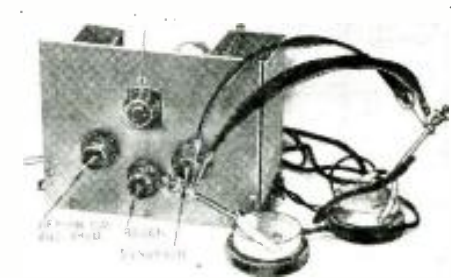

Here is the dynatron set ready to operate.

adjust dynatron control R2 for greatest sensitivity.

Gridleak R3 preferably is of the plunger type, and is best adjusted with both R1 and R2 adjusted for minimum sensitivity. After finding the most sensitive position for R3, R1 and R2 may then be adjusted as previously described.

These adjustments are extremely easy to make and will afford endless interest.

(Continued on page 58)

Rear view, with batteries moved aside.

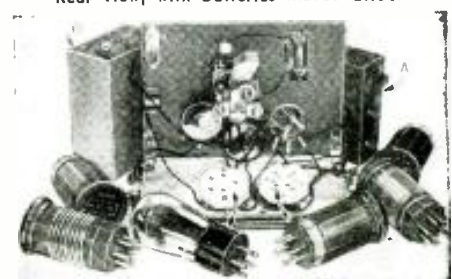
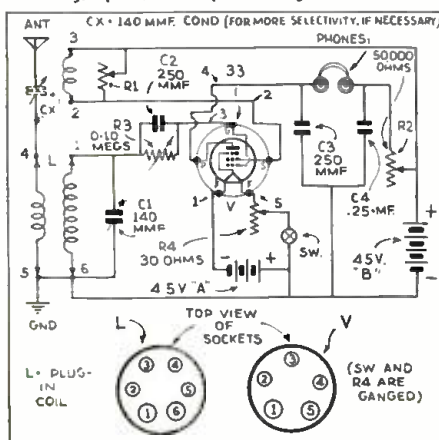
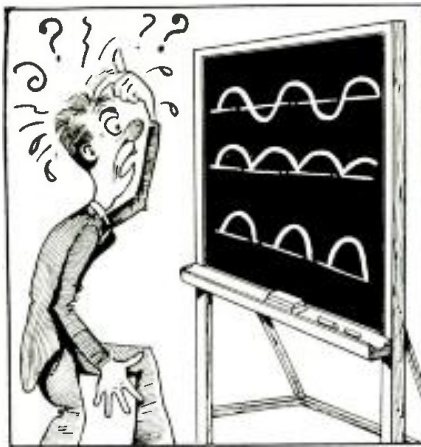

Fig. 1. The circuit, including all values.



# READERS' DEPARTMENT

A department in which the reader may exchange thoughts and ideas with other readers.



Is A.C., A.C. or is it D.C.? It seems that at least one reader is completely in a dilemma.

## A READER IN A QUANDARY

Editor, RADIO-CRAFT:

I have occasion to do some "sound" work in independent theatres which brings about a question. I've been servicing radio sets for eleven years—I am a graduate of a well known resident radio school—and yet I must admit that the theatre manager of one of the theatres I work in stumped me on a "honey" of a question. It was this:

Is the current flowing in the voice coil line (from the output transformer) A.C. or D.C.?

Instantly my mind popped to the conventional  $\frac{dI_p}{dE_s}$  chart which shows a sine wave. In every tube chart I have encountered this has been the case. Now how can the output of a PE. cell (which is strictly a rectifier—uni-directional) be fed through a vacuum tube amplifier and supply the sine wave output? I know there is such a thing as pulsating D.C. which never reverses in direction and I know that radio frequency waves are A.C. but we are dealing with uni-directional pulsating currents.

And as for class B amplification, in which one tube takes the place of the tank circuit—they tell me that one tube works on the other. Now how is pulsating D.C. going to affect that (second) grid so that it works in the way mentioned. And take push-pull too! Boy, oh boy, I'm really tied up in a knot—it is A.C. yet it is D.C.

I tried measuring the voice coil voltage on D.C.—it would not read. On A.C. it would, providing we ran our hands up and down between the exciter lamp and the PE. cell to get a pulsating D.C. What accounts for that double click when the hand is run by the PE. cell. Is it really A.C.?

But as for taking the output of a PE. cell, feeding it to a biased grid

and then receiving A.C. in the plate circuit. Maybe its the same old "racket" of two plate components—D.C. voltage and an A.C. voltage.

I'm beginning to see light now—we do have an alternating grid voltage, at that, don't we, either more or less negative as the bias is increased or decreased, but the input never alternates from positive to negative. It is still uni-directional, but I see now why we get a sine wave output.

LARRY L. JOLWIN  
Willcox,  
Arizona.

We wonder how many of our readers are confused by such problems. Mr. Jolwin, of course, answered his own questions, after puzzling over the various points involved.

It is well to remember that if an alternating current or a pulsating current is applied to the primary of a transformer, the output is always alternating. And the same applies to the use of a tube as an amplifier. The output is A.C., though it may be mixed with the constant direct potential of the plate supply.

An occasional review of the principles of electricity is really worthwhile both for the "old timer" and the "newcomer" in radio. May we suggest the article—"Modern Theory of Electricity" in the March, 1935 issue of RADIO-CRAFT?

## A STATION CORRECTION

Editor, RADIO-CRAFT:

I notice that in your January 1935 issue you have one of our stations listed as VE9JR—11715 kc. This should be CJRX—11720 kc.

You also list VE9DR—11720 kc. This I believe must be a printer's error as I know of no station of that frequency with those call letters here. Most likely, this is confused with the above station VE9JR which call letters have been changed to CJRX.

Our other short-wave station, CJRO—6150 kc. is listed correctly.

W. V. MCLAUGHLIN,  
Radio Station CJRC  
Winnipeg, Man. Canada.

Thank you very much, Mr. McLaughlin, for this information. It will assist us materially to receive authentic reports like yours, in the compilation of our station lists which we publish from time to time.

May we suggest that officials of other stations cooperate with us in keeping station "statistics" straight?

## ONE SERVICE MAN'S STORY

Editor, RADIO-CRAFT:

The things that happened to me during the past two months may be of interest to other Service Men who read your publication.

I have been doing service work for some time but had not gotten very far as money was concerned. So I decided to do something about it. The first idea was to mail cards to people and tell them I was doing service work, etc. The money that I spent on cards, printing, etc., was wasted.

The next one was the old one about cutting prices—and let me tell you that whatever you do, do not think that this idea will bring in the calls which have profit in them, because the only ones that will come in are from people who are looking for something for nothing. This idea was just as bad as the first, if not worse.

Then the third idea arose. I thought that I was not seeing enough people—if I could see more people the law of averages might take care of my calls.

With this in mind, I got the best tube tester that I could buy—one that would show leakage and short-circuit conditions, etc., and a complete stock of tubes. I also stocked the new aerials.

So with the tubes and aerials, I  
(Continued on page 63)

Two views of an interesting servicing organization which uses a "line" procedure.

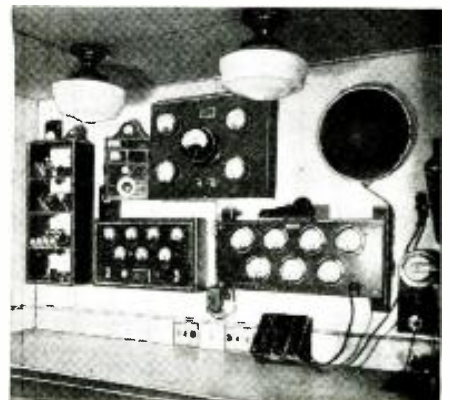
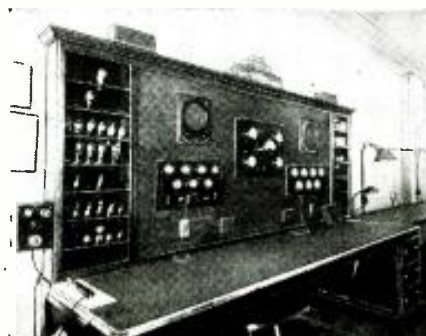



# THE LISTENING POST FOR ALL-WAVE DX-ERS

C. A. MORRISON



The main control desk of the 300 kw. Bisamberg station at Vienna, Austria.

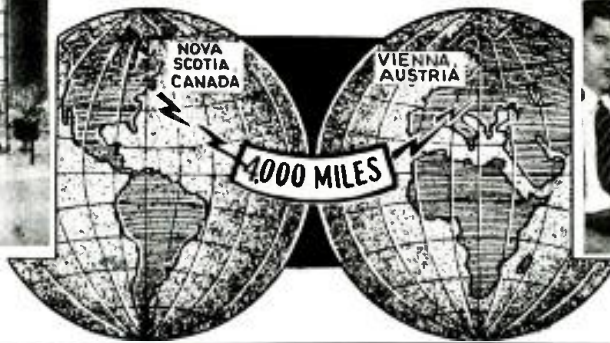

The listening post of Mr. Baines in Sydney Mines, Nova Scotia.

**E**VEN to the uninitiated there is something of irresistible fascination about the well equipped 'DX Shack' of an ardent DX-er. (It should be explained that the listening post of a 'dyed in the wool' DX fan is always his 'Shack,' whether it is actually a shack built for the purpose or in a beautifully appointed room in a private home.) There is something of undeniable interest in the large wall maps, world globes, gay verifications, dials, meters and endless wires. The walls of such rooms seem to recede and embrace the whole world as the DX-er speaks carelessly and familiarly of Bombay, Melbourne, Paris and the Belgian Congo.

Recently it was my pleasure to visit the "ideal" listening post, which has been appropriately called by its rather eccentric owner "Reception Refuge."

First, I would like to point out the geographic isolation of the place. The home of which I speak is situated about ten miles from any manufacturing or industrial districts, and several blocks from the closest thoroughfare, by private road. The house itself stands on a fairly prominent hill well above the tops of the splendid forest of trees with which the surrounding hills are covered. To one side of the house is a beautiful little lake.

Four antenna masts, painted in striking bands of black and white rise some 50 ft. above the top of the hill. These substantially erected masts carry two all-wave antennas of the doublet type. One runs in a North West by South East direction, and the other in a North East by South West direction. These antennas are connected with the house by transmission leads which have been buried under the ground in a special conduit. The transmission leads are some 200 ft. in length. From the top of one of the masts, one end of an inverted 'L' antenna is fastened, which then runs in a South West direction to the top of another rise of ground some 600 ft. away, where it is connected to another high mast, well above the tops of the trees. With some pride the owner next showed me his 'Vertical Antenna,' which is constructed of 1½ in. copper tubing some 36 ft. high, and set in a carefully insulated base of porcelain.

Although I did not see the ground system employed at "Reception Refuge," the owner told me that he had two sets of grounds. One a system of buried counterpoises directly under the doublets, and the other a system of four of the well

known 'Ollie Ross' grounds each buried some eight feet in the ground, and in an especially constructed plot of earth which is kept permanently moist by a small stream of water from an underground water pipe automatically pumped in from the lake.

The house itself is of rather unique and interesting architectural construction, but for our purpose the most outstanding feature is a tower room which has been built on one of the side wings, and is flanked on three sides by glass enclosed walls, and also a removable glass roof such as is sometimes seen in observatories. This glass roof is protected by a wooden framework which is put on during the winter time. The room is about 15 ft. by 15 ft. in size. My guide explained that this was his 'shack,' and where he spent most of his time.

Inasmuch as we had arrived at "Reception Refuge" near dinner time, we did not go immediately to the 'shack' but were invited into the dining room shortly after our arrival. One wall of this dining room contained a huge and elaborately built-in grille, which our host explained concealed one of the rather complete system of built-in power speakers, which could furnish selected programs to any part of the house at will. We had just got comfortably seated at the table, when some sort of an automatic relay went on with a click and a hiss from the wall speaker betokened it was in circuit. And then came a most agreeable surprise as we heard the familiar chimes of Westminster ring out clear as a bell. Conversation naturally came to a stand-still as we waited in hushed expectancy for the first booming strokes of Big Ben so many thousands of miles away. It filled the room with its echoing volume, and then came that famous announce-

ment "This is London calling, on GSA. "A" for aerial, and on GSC. "C" for corporation. I have heard this same announcement many, many times but never under the same circumstances or with such a thrill. 'Big Ben' was followed by a program of light dinner dance music played by the B.B.C. dance orchestra. The speaker had been turned down in volume for this music to make an agreeable background for the conversation. Our host told us that after dinner he would take us up to the shack where he thought he could show us some interesting things. . . . (Next month the writer will continue this little account of his visit to "Reception Refuge")

(Continued on page 57)

Don't forget that each month RADIO-CRAFT gives valuable prizes for the best verifications received. See page 689, May 1935 issue.

Here is the antenna network of the powerful Droitwich broadcast station; the largest station in England.

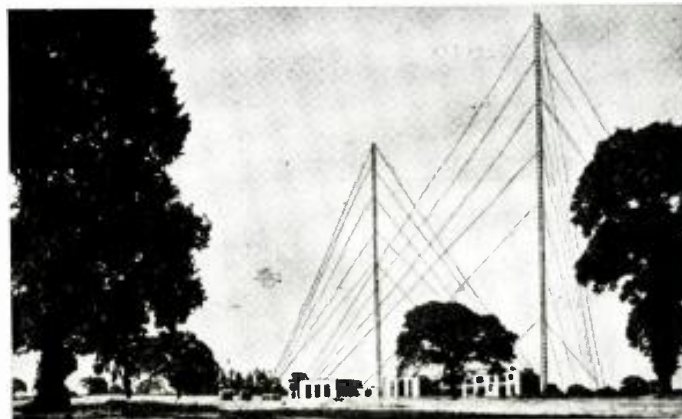

# THE ANALYSIS of RADIO RECEIVER SYMPTOMS OPERATING NOTES

## THE PURPOSE OF THIS DEPARTMENT

It is conducted especially for the professional Service Man. In it will be found the most unusual troubles encountered in radio service work, written in a practical manner, by Service Men for you.

Have you, as a professional man, encountered any unusual or interesting Service Kinks that may help your fellow workers? If so, let us have them. They will be paid for, upon publication, at regular space rates.

### MAJESTIC 90

THIS set had a bad tunable hum and we had plenty of grief finding the trouble. We tried tubes known to be good and even tried a different power pack. We tried everything known and finally, for no reason at all changed the R.F. choke in the antenna circuit after which the set worked OK. (See Fig. 1A). The old one was torn apart and under the wax impregnation it was found to be charred and many layers had shorted together as if a lightning charge had gone through it. An ohmmeter had indicated about 25 ohms resistance and we assumed that was the normal value.

### CROSLLEY 167

THIS set came in with the complaint of smoke coming out of the chassis. Upon investigation the 750 ohm flexible resistor in the output cathode circuit was found to be badly charred and smoked when the set was turned on. In this set, the 8 mf. cathode bypass is in the same case as the 6 mf. filter condenser. The positive 6 mf. section shorted internally to the positive cathode section, the high voltage going to ground through the cathode resistor, burning it up. Replacement of the resistor and condenser units effected a complete repair. See Fig. 1B.

### CROSLLEY 159

SOME time later, a Crosley 159 came in dead. This is a 32 V. model and we had no way of operating it. The

cathode resistor in the 43 output circuit was badly charred and we expected to find an internal short in the bypass-filter unit as given above. It checked OK, but we changed it anyway as we could find nothing else wrong. The set has been operating ever since.

### RADIOLA 44, 46 & 47

ON these models, the tuning condenser rotor bearings wear, allowing the rotor to slip slightly in a side direction. This changes the tuning condenser capacity thus throwing the set out of alignment, especially at the low frequency end. Proceed as follows: turn the dial until the plates mesh, unloosen the screws holding the stator sections, move the stator plates slightly with a screwdriver until they are equi-distant from the rotor plates and tighten them in place. Adjust each section in this way. It may be necessary in some cases to remove the small bakelite stator supports and ream out the holes to allow enough movement. Finally realign the trimmers at the high frequency end of the dial.

### RECTIFIER TUBES

WE HAVE had several midget sets come in with the complaint of low volume or completely dead. The owners said they had the tubes tested elsewhere and they checked OK. For a while we took their word and looked the set over and found low plate voltages all around, but no short or open anywhere. Then we would find a low

emission rectifier, such as a 1V, 12Z3, 25Z5, etc. It seems that some tube testers don't put enough load on the rectifier and it will sometimes test OK. It might be wise for the Service Man to check over his tube checker to see if that happens. A good method is to keep a good set of rectifiers on the bench to use in place of those suspected of low emission. (Be careful, though; a shorted input filter condenser will blow the rectifier tube every time.)

We have seen type 80s do the same thing. A simple check is to turn it upside down and note the amount of oxide that has come loose from the filament. If very much has come off, replace the tube regardless how it tests. Also, a low emission 80 will often cause abnormal hum.

A quick check on the small rectifiers of the heater types (1V, 12Z3, 25Z5, etc.) is to note the small wire from the stem to the cathode proper inside the bulb. A short circuit or heavy overload somewhere will burn this wire entirely off. The tube is built to do that; otherwise the cathode will short to the plate and blow a line fuse or cause other damage. Keep that in mind when working with these tubes; don't overload them or they will go "west" quickly.

Majestic Treasure Chest (chassis 380) used a 2½ V. half-wave thermionic rectifier, type G-84, sometimes called 2Z3. These tubes are hard to procure and we replace them with an 82. The filament winding seems to stand the extra load OK. It is necessary to pull the chassis and disconnect one side of the A.C. line from the unused terminal of the rectifier socket. It is bad business to use an electrolytic condenser at the input of the filter, when using a mercury-vapor rectifier, so we put a 4 mf. 600 V. paper condenser at the input to the filter. This rarely entails extra cost as the condenser block generally needs replacement anyway.

R. M. DAMM

(Continued on page 60)

Fig. 1  
Circuit details for Majestic 90 and Crosley 167.

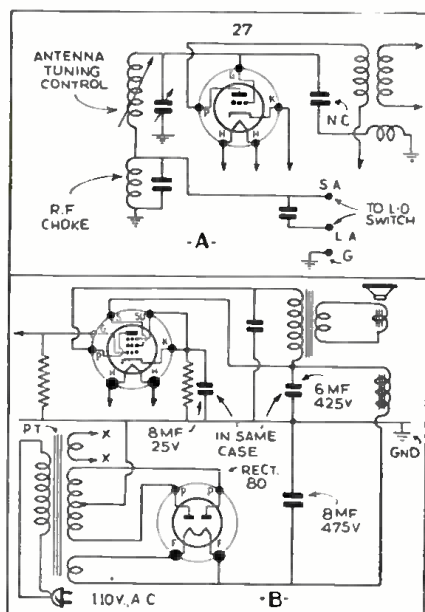

Fig. 2  
Reducing hum in a Howard model E14.

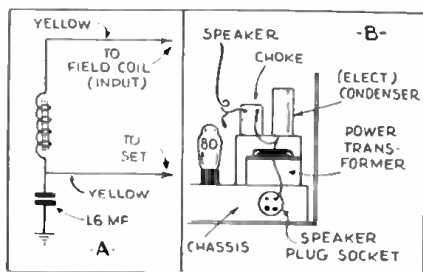
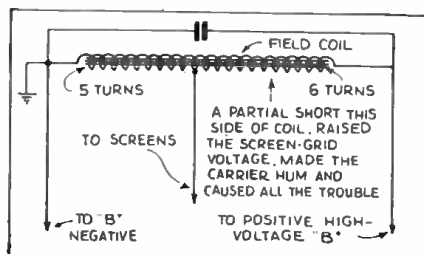

Fig. 3  
A baffling case of hum in a Zenith 410 receiver was finally traced to the speaker field which had a partial short circuit.





# THE "ULTRA-MODERN SUPERHET." NOW ALL-WAVE

This old favorite of RADIO-CRAFT readers has been completely revamped to include both short-wave and broadcast frequencies.

CLIFFORD E. DENTON



THE requirements for any successful receiver vary with time. Some years ago it was necessary for any superheterodyne to have high amplification, regardless of selectivity, for the tubes then available all had low gain, which had to be compensated for by adding more stages and increasing the gain-per-stage; the latter being obtained by using a low I.F. With the development of high-gain tubes, it became a relatively simple matter to secure high amplification, and the attention of set engineers was turned to obtaining greater selectivity. As we all know, this was finally obtained by employing a high intermediate frequency and well-designed tuned circuits.

And then short-wave radio sections were added to receivers, and the requirements for selectivity became even greater, as did high stage gain at the very high frequencies. Plug-in coils were used to retain every bit of available energy, and it was not until good switches were available that the plug-in coils went into discard, except in simple receivers and those intended for

specialized work.

The new Ultra-Modern Superheterodyne to be described here, is an answer to these requirements, and represents the latest developments in superheterodyne design.

## THE CIRCUIT

The schematic circuit of Fig. 1, and the accompanying photographs tell the entire story. The set consists of a tuned R.F. stage (6D6), a mixer and oscillator stage (6A7), an I.F. stage using the tetrode section of a 6F7 as the amplifier and the triode portion as a beat oscillator, and a diode second detector; the pentode section of this latter tube, which is a 6B7, is used as the first A.F. amplifier.

Audio amplification is secured by the use of two 6B5 tubes, which were described by the writer in the March 1935 issue of RADIO-CRAFT. Let us consider the circuit in more detail.

Five bands are used in all. Thus, there are five antenna coils, five R.F. coils feeding the mixer (2A7), and five oscillator coils, connected to the triode portion of the 6A7. Each set is con-

nected and switched as shown in the sketch of Fig. 2. The common lead to all coils connects to ground; to the decoupling resistors R1; to "B plus," or to the oscillator padding condenser C11, depending upon the circuit considered. At each position of the switch, the set of connections are as shown in the diagram of Fig. 1.

The wave- (Continued on page 59)

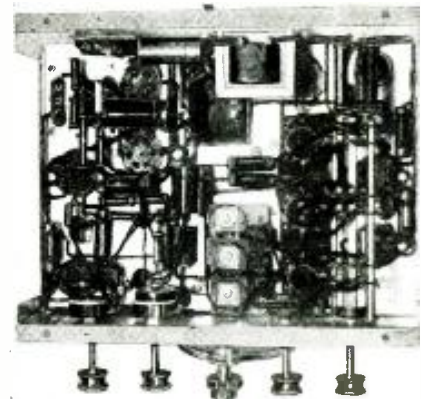
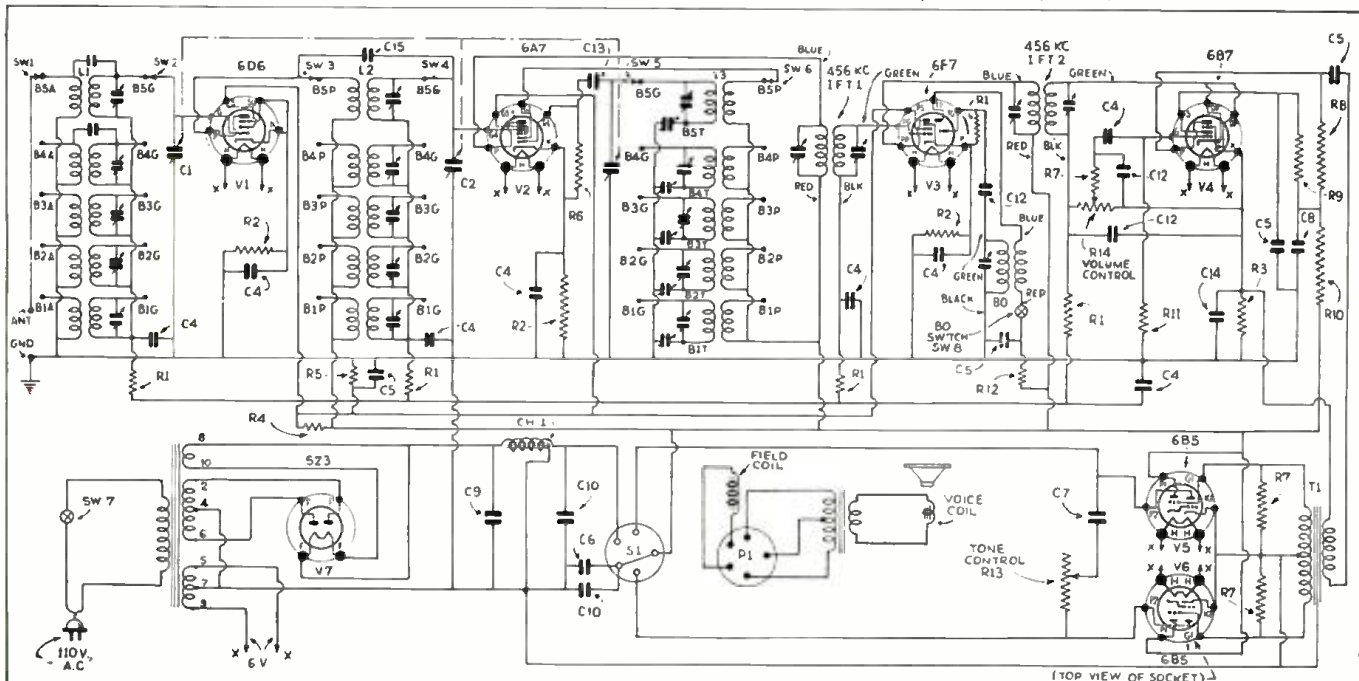

Fig. B  
The under-chassis view of the complete set.

Fig. 1—The circuit of the set with all values indicated. The 6F7 acts as an I.F. amplifier and beat oscillator.



# RADIO-CRAFT'S INFORMATION BUREAU

## OSCILLATOR FOR A.C. OR D.C.

(328) Mr. A. L. Raymond, Arriba, Col.  
(Q.) I should like to see you publish a hook-up, including constants, for a service oscillator employing a type 32 tube in dynatron arrangement.

(A.) The circuit of Fig. Q328 shows a dynatron oscillator arranged to operate directly from the 110 V. line; the voltage may be either A.C. or D.C. In case of D.C. the polarity must be as indicated on the diagram.

The necessary potentials for the filament, screen-grid and plate are obtained by means of four sliding rings making contact on a 2000 ohm 25 W. variable resistor. The values shown are only approximate since the voltages have to be adjusted until the oscillator operates properly. All other constants are clearly shown on the diagram. The attenuator is a 0.5-meg. potentiometer.

If the oscillator is to be used for broadcast work entirely, then the inductance L can be an old radio frequency transformer. When more than one band is to be covered the oscillator should be made for plug-in coils.

It will be necessary to try several tubes in the circuit in order to obtain one that will oscillate properly. This is due to the variation in negative grid resistance among screen-grid tubes.

## CONDENSER TESTER

(329) Mr. Frank Curley, Oakland, Cal.

(Q.) We are desirous of constructing an electrolytic condenser tester for our service shop. Will you kindly print a diagram of one that can be made from spare parts?

(A.) In order to measure the leakage of an electrolytic condenser the circuit shown in Fig. Q 329 is recommended. It can be made of old parts lying around the bench and will prove very valuable.

The electrolytic condenser can be hooked to the positive terminal on the tester and the positive lead to the positive terminal. The milliammeter is short-circuited by switch Sw.2 and then switch is turned on. Clip C is adjusted to the working voltage of the condenser under test.

The condenser should have about 50 seconds to fully charge and then switch Sw.2 is

(Continued on page 61)

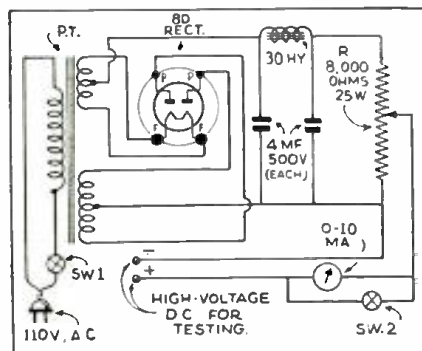
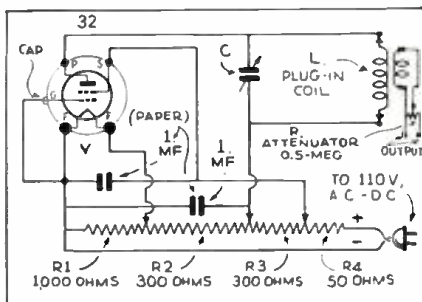

## P.A. QUESTIONS & ANSWERS

Here is a new department for the Radio Dealer, Service Man and Sound Technician who require general information and help in P.A. work. This department will furnish valuable aid for the asking. Address all questions to RADIO-CRAFT'S Public Address Forum. Only those questions of general interest will be published and we reserve the right to publish any of these inquiries and answers.

### MOUNTING SPEAKERS IN A SOUND TRUCK

(1) Mr. Leo Lipshitz, Brockton, Mass.

(Q.) What is the most efficient manner of installing two dynamic speakers in a small sound truck so as to afford protection to the speakers and to secure maximum sound distribution on both sides of the street?

(A.) See Fig. 1A—Both speakers should be mounted inside the truck midway between both sides and elevated from the floor to one half the total height of the body. The length of the truck body should be divided into four equal parts. Then one speaker should be mounted at the first division facing either one of the two sides. The second speaker should be mounted at the third division and at a 180 degree angle to the first speaker. Two square or round trumpets are then built from the front and rear of each speaker to both sides where suitable openings are provided. This type of installation utilizes the rear and front sound waves produced by the speakers and provides approximately 75 per cent more effective sound than does the ordinary type of installation where the speakers are mounted directly to the sides of the trucks.

### UNIVERSAL SPEAKER OPERATION

(2) James Stafford, Seattle, Wash.

(Q.) How can I use a 6 volt dynamic speaker on a 110 V. line as well as from a storage battery?

(A.) Figure 1B shows the wiring and parts required to adopt your speaker for universal operation.

(Continued on page 61)

Fig. Q328 (left)  
The circuit of the A.C.-D.C. dynatron oscillator.

Fig. Q329 (lower left)  
A useful electrolytic condenser tester.

Fig. Q1 (below)  
An efficient speaker housing—and field supply.

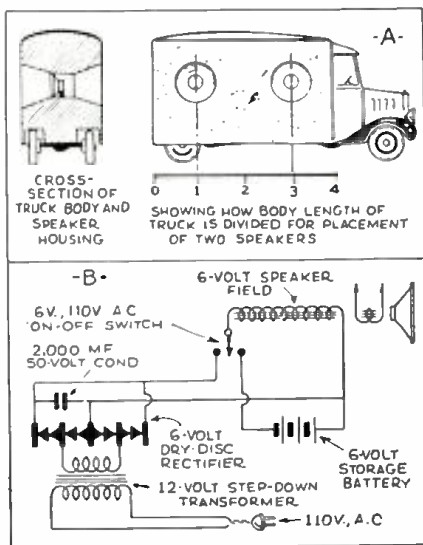

## SPECIAL NOTICE

Those questions which are found to represent the greatest general interest will be published here, to the extent that space permits. (At least 5 weeks must elapse between the receipt of a question and the appearance of its answer here.) Mark such inquiries, "For Publication."

Replies, magazines, etc., cannot be sent C.O.D. Back issues of RADIO-CRAFT prior to December, 1932, are available at 50c per copy; except the following issues: 7/29, 1, 2, 3, 4, 6, 7, 9 and 11/30; 5, 8 and 9/31; and 7/33, which are out of print. Succeeding issues are still available at the regular price of 25c per copy.

Inquiries to be answered by mail MUST be accompanied by 25c (stamps) for each separate question; answers are subject to subsequent publication if considered of exceptional interest.

Furnish sufficient information (in reference to magazine articles, be sure to mention issue, page, title, author and figure numbers), and draw a careful diagram (on separate paper) when needed to explain your meaning; use only one side of the paper. List each question. Be SURE to sign your name AND address.

Enclose only a STAMPED and self-addressed envelope for names and addresses of manufacturers; or, in connection with correspondence concerning corrections to articles, as this information is gratis.

Individual designs can be furnished at an additional service charge. The fee may be secured by addressing the inquiry to the SPECIAL SERVICE department, and furnishing COMPLETE specifications of desired information and available data.

## RADIO-CRAFT ITEMS OF INTEREST TO SERVICE MEN

ARTICLE	Issue	Page
The N. R. I. Set Tester	July, 1933	11
*Applications and Characteristics of Copper-Oxide Rectifiers	July, 1933	18
Building the Simplicity Analyzer Unit	July, 1933	20
*Point-to-Point Capacity Testing	July, 1933	26
Building an A. C.-Operated V. T. Voltmeter	July, 1933	30
*Locating and Correcting Troubles in Phonograph Pickups	July, 1933	31
How to Build a Portable Service Kit	Aug., 1933	82
Constructing the Dependable Tube Tester	Aug., 1933	86
A Modern Bench Type Test Panel	Aug., 1933	104
Operating Conditions for Successful Demonstration	Aug., 1933	122
The Design Principles of an All-Purpose Tester	Aug., 1933	148
New Adapters for Modernizing Radio Equipment	Sept., 1933	152
How to Construct a Decade Condenser	Sept., 1933	163
A Valuable Resistor-Condenser Chart	Sept., 1933	164
Testing Resistors	Sept., 1933	186
A Multi-Purpose Test Instrument	Oct., 1933	204
Testing by "Selective Analysis"	Oct., 1933	204
How to Bring Your RADIO-CRAFT Universal Analyzer Up-to-Date	Oct., 1933	218
How to Make the New "Analyzer Unit"	Oct., 1933	220
*Questions and Answers on P. A. Sound Systems	Oct., 1933	221
Converting D. C. Dynamics for A. C.	Oct., 1933	227
Inductance Table	Oct., 1933	230
A New Test Oscillator	Nov., 1933	267
Servicing the "Talkies" (Part I)	Nov., 1933	274
*How to Make your Own Transformers and Chokes (Part I)	Nov., 1933	280
The Maintenance of Carbon Microphones	Nov., 1933	287
Eliminating Auto-Radio Noises	Nov., 1933	288
Measuring Small Capacities	Nov., 1933	289
A 5-Unit Radio Tester	Dec., 1933	337
*Placing Parts to Avoid Inter-Acting Fields	Dec., 1933	344
Servicing the "Talkies" (Part II)	Dec., 1933	347
*Servicing by Stage Analysis	Dec., 1933	348
How to Make a Radio Growler	Jan., 1934	398
*Checking up Those R. F. Chokes	Jan., 1934	402
Servicing the "Talkies" (Part III)	Jan., 1934	408
*Transformers and Chokes (Part II)	Jan., 1934	409
How to Make and Operate an Ultra-Modern Set Analyzer	Jan., 1934	410
Making a Diode Multimeter	Jan., 1934	412
A Neon-Type, Meterless Checker	Jan., 1934	413
Electrolytic Condensers at High Voltages	Jan., 1934	443
Electron-Coupled Service Oscillator	Feb., 1934	459
An Adjustable Scratch Filter	Feb., 1934	460
Resistance-Capacity Tester Improved	Feb., 1934	473
Servicing the "Talkies" (Part IV)	Feb., 1934	476
A 110 V., D. C. Tube Checker Attachment	Feb., 1934	477
A Universal Analyzer and Tube Checker	Mar., 1934	524
A Low-Voltage Pentode Oscillator	Mar., 1934	528
Cathode-Ray Tuning Indicator	Mar., 1934	528
A Home-Made Transformer Flasher	Mar., 1934	530
*Measuring Wire Gauge with a Meter and Battery	Mar., 1934	531
Marking Panels	Mar., 1934	531

(Continued on page 61)





A department devoted to members and those interested in the Official Radio Service Men's Association. It is the medium for exchanging ideas, kinks, gossip and notes of interest to Service Men, or others interested in servicing.

## RE: SERVICE MEN'S UNION

RADIO-CRAFT, ORSMA Department:

In reply to Mr. D. W. Cline of Hamilton, Ontario, Canada, regarding a Service Men's union; I have been in the radio business in Hamilton for about seven years—three years doing radio service for radio dealers and the last four years in business for myself.

I will say the radio business is not what it should be, but what business is these days? However I am making a living and I believe all the rest of the Service Men are too. I do not know Mr. Cline and I cannot find any other Service Man who does. I have asked a lot of the Service Men and they all tell me that they do not know him. I have never seen any advertising that he has done, in any form, and how can one expect to get any work if one does not advertise in some way or other?

With regards to the statement that a local store laid off their two Service Men and advertised for a new Service Man, I believe there are only three stores in Hamilton that have two Service Men or more and they still have the same men. I have not seen any advertisement in the papers for a Service Man since last summer. I will say that the local stores do not pay big money, as there is one local store (and it is supposed to be a leading one) that is only paying six dollars a week to a Service Man and he works almost every day until eleven or twelve o'clock. But any Service Man who works for that, should not get any more!

I would also like to know how a man is going to do service work and make his calls in a street car. If a set has to come into the shop for repairs, what is he going to do; take the set under his arm and carry it in the street car? I am afraid he will have quite a load, as some sets are a little bit heavy!

In cutting prices, I may say that the local stores do not cut prices—it is the Service Men who cut them. There are a lot of boys here going to technical school who are satisfied so long as they can make 50 cents or a dollar for spending money.

Regarding the formation of a local Union, I called a meeting last summer to see if we would form some kind of an organization and out of 15 or 20 Service Men I asked to come, there were only 6 who showed up at the meeting and they were just like mules. I guess everybody is out for themselves.

I wish you would print this letter in our ORSMA page as I do not want Service Men to think that Hamilton is too bad a place to work in.

H. B. AULENBACK,  
Hamilton, Ont., Can.

Thank you for your letter Mr. Aulenback. It is interest-

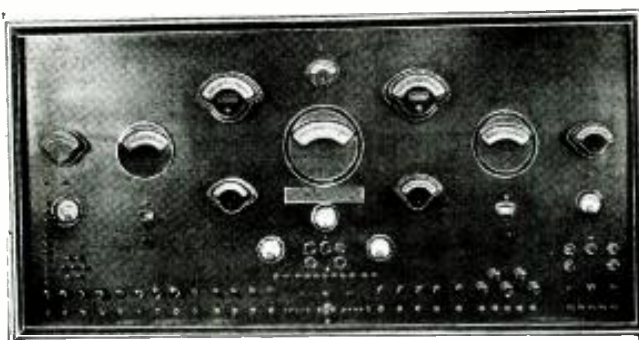

A Fine Test Board—in the service shop of Aspeck and Valois, in Montreal, Canada. It includes a tube tester, ohmmeter, grid dip oscillator, set analyzer, capacity tester, calibrated service oscillator, output meter, universal reproducer and built-in power supply.

ing to get a second opinion of the conditions in your city.

With reference to your experiences in forming a local organization of Service Men, we are sure that if the men in your city are approached in the right way, and at a time when business permits them to attend a meeting, they will be willing to cooperate for their own good. It takes time, though, to band a group of men together in this way, especially if their available time is uncertain.

Perhaps if meetings were called to hear lectures on servicing, etc., and the organization problem was broached later, you could get more cooperation. Without doubt some of the local "authorities" on radio—either teachers or established business men—could be induced to give short talks on interesting subjects—and this would be a real inducement for the men to attend.

If the ORSMA can be of any assistance, you can rest assured that we will be only too glad to help.

## A CONDENSER TESTER

RADIO-CRAFT, ORSMA Department:

I am sending the circuit of a condenser tester which should find many applications in any Service shop.

The diagram is self-explanatory, and building the unit should be an easy problem for any Service Man to solve.

In operation, if a condenser is (Continued on page 63)

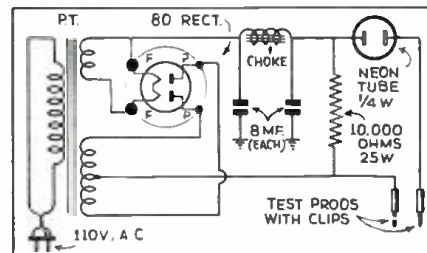

A simple, reliable condenser tester described by Mr. Kafoury; it tells if a condenser is shorted, open or leaky.

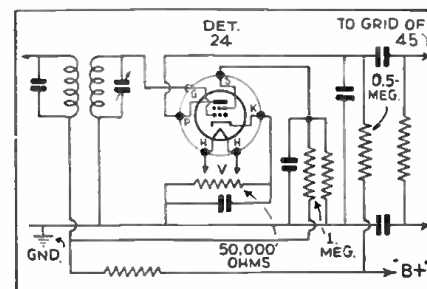

An odd effect took place when the plate and screen-grid resistors in the Echophone 53 detector circuit changed in value.

GENERAL ELECTRIC MODEL D-72 7-TUBE "DE LUXE" AUTO RECEIVER

(Uses a noise filter, and new location for ground; tunes from 540 kc. to 1,600 kc. Power supply is the case of the remote, 8-in. reproducer.)

This auto receiver contains several new features, which are the location of power supply in the speaker case, a special combination transmission line and "noise filter" for attenuating interference, and the removal of the ground from the input coil to a part of the transmission line lead-in.

The equipment provided for inversion of the regular storage-battery supply to the high voltage required for plate and grid potentials consists of a combination vibrator and tuberectifier unit. The assembly is installed within the loudspeaker housing, and its output conducted to the receiver chassis through a double shielded cable. This separate layout of power-supply unit and receiver chassis minimizes disturbances likely to be introduced from proximity of the two, in combined assemblies.

The following describes the functions of the various stages of the receiver: Beginning at the antenna circuit, there is a special transmission line and "noise filter" circuit, which, in conjunction with the tuned input system, acts selectively to the entire broadcast range and drastically attenuates signals and interference outside the limits of the band (540 to 1,600 kc.). These properties of the filter circuit and minimizing of primary to secondary capacity coupling in first R.F. transformer cause a very great reduction of the ignition noise present when the car is in operation. The ground of the input coil does not appear at the usual point on the chassis frame, but instead is extended as part of the antenna transmission line lead-in to the outer termination of the shield, where it grounds to the frame of the car. This arrangement prevents R.F. disturbances which are circulating in the car frame (ground) from becoming mutual to the receiver input. The characteristics of the transmission line section of the antenna lead-in are such as to favor the operation of the noise filter. Its distributed capacitance due to length, conductor sizes, insulation, etc., is of such value as to operate with the inductance and capacitance elements of the input system to obtain a "band-pass" filtering effect. The filter has an acceptance band between 540 kc. and 1,600 kc., and sharply defined cut-off below and above these two limits. It is generally possible, because of this input arrangement, to dispense with the usual spark-plug and distributor suppressors without encountering substantial ignition interference on latest types of cars.

The tuning condenser flexible shaft engages a gear system within the control unit which actuates the dial pointer. To adjust the mechanical relations of the variable condenser and the dial pointer so that accurate calibration

is obtained—rotate the station selector knob until the variable condenser is at full mesh, which will carry the dial pointer to its minimum frequency position; then remove the tuning knob, loosen the set screw in the bushing and rotate the bushing until the pointer sets exactly opposite the last radial line at the low-frequency end of the scale. (The line referred to is the second one counter-clockwise of the 550 kc. marking.)

The battery rating for these figures is 6.3 V.; the set is adjusted for no signal and maximum sensitivity. All the voltages in this tabulation are read to chassis.

Tube Type	Cath. Volts	S.-G. Volts	Plate Volts
V1	5.2	90	215
V2**	5.2	90	215
V3	3.4	90	215
V4	.....	15	63
V5	12.7	---	252
V6	.....	---	260
V7	264	---	---

\*\*Oscillator plate, 215 V.

Three trimmers are provided in the I.F. system. Two are located on the first I.F. transformer, and one on the second I.F. transformer.

To correct their alignment proceed as follows:

(a) Connect the output of a "Full Range Oscillator" to the first detector grid and ground, and adjust its frequency to 175 kc. Tune the station selector to a point where no signals are received.

(b) Tune each of the trimmer condensers C19, C18 and C17 in order. C19 should be set for maximum (peak) output. C18 and C17 should be roughly adjusted for maximum output and then carefully "trimmed" so that a flat-topped response is obtained. This may be checked by shifting the external oscillator frequency through a range 2 kc. each side of the 175 kc. and noting whether or not the receiver output remains substantially constant.

Three adjustments are used at the high-frequency end of the tuning range. They are located on the gang condenser. One trimmer (C-9) is used in the oscillator circuit for alignment at 600 kc.

The external oscillator should be connected to the antenna-ground input at the outer end of the lead-in shield through a 300-ohm resistor in the antenna side. Tuning should be done as follows:

(a) Adjust the frequency of the external oscillator to 1,400 kc. and turn the station selector until the dial pointer is at the 1,400 kc. marking.

(b) Tune the oscillator high-frequency trimmer, C12, the detector trimmer C8 and the R.F. trimmer C4 for maximum receiver output.

(c) Set the external oscillator to a frequency of 600 kc. and rotate the station selector until this signal is accurately tuned. Then adjust the oscillator trimmer C9, simultaneously rocking the tuning condenser slowly through the signal until maximum obtainable output results from the two combined operations. This adjustment should be made irrespective of dial calibration.

(d) Recheck the adjustment of the 1,400 kc. oscillator trimmer (C12) as in (b) to correct any reflective errors caused by the procedure of (c).

A novel type of mounting is provided for the pilot lamp. It consists of a miniature socket attached to a heavy screw which threads into the case of the control unit. The head of this screw is accessible from the underside of the control unit and may be removed with a large screwdriver whenever it becomes necessary to replace the pilot lamp. The power switch should be turned to "off" in order to prevent blowing the fuse if the lamp socket should come in contact with the grounded control case.

The grounding of the motor end of the antenna lead shield is quite critical in that ignition interference may be minimized by selecting the proper point of attachment to the car frame, determined by experiment for each individual installation.

In some cars, ignition interference may be introduced through lack of sufficient shielding on the antenna lead-in. In such cases, a shield should be placed over the exposed section of lead and carried as near to the antenna as possible. It should be solidly grounded.

Interference in the form of a grating scratch may arise from static collecting on the front wheels of the car due to road surface friction in dry weather. The insulation caused by the grease of the wheel hub enables this action to develop. A number of devices are available through automotive supply dealers which are designed to eliminate this type of trouble. They all serve to form a solid grounding tie between the hub and the axle, and thus drain the static to the frame of the car (ground).

In the event the cone coil becomes misaligned, it will be necessary to correct its centering by an adjustment provided on the speaker assembly.

The screws holding the chassis to the case must all be in place and tightly installed, inasmuch as they appreciably effect the ground resistance of the assembly and will consequently have a bearing on the amount of ignition noise received.

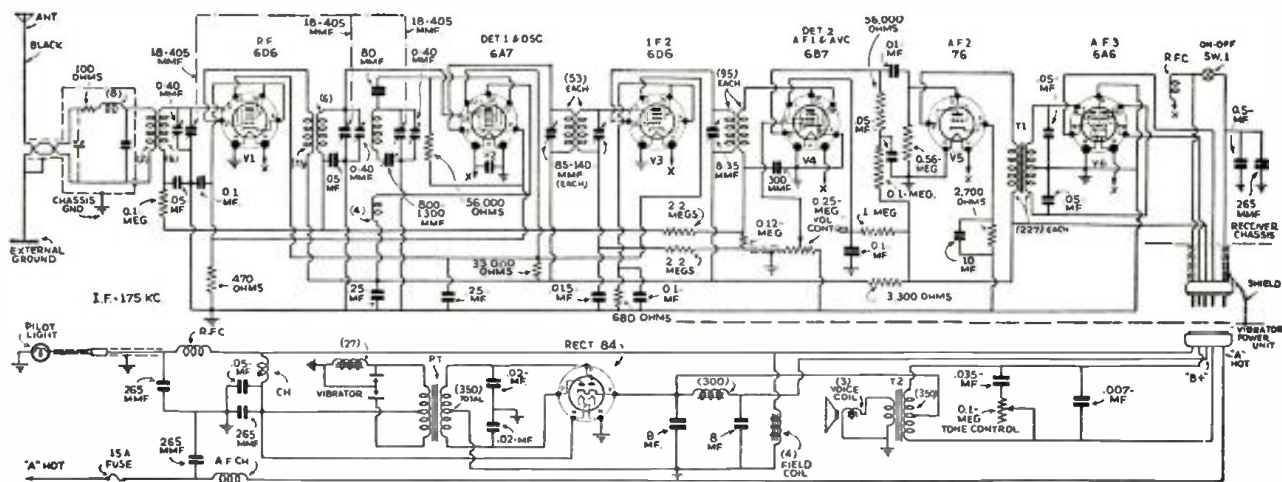





RCA Universal Power Transformer, Stock No. 9551, for 10 to 12-tube sets. List \$6.00

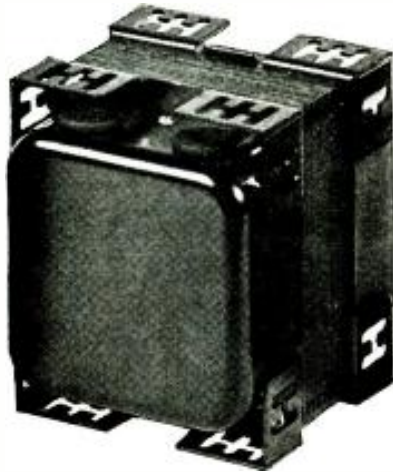

## Transformer Stocks Simplified

- Four RCA power transformers and one type of output transformer will now cover all replacement needs. Thus only these five types need be stocked, greatly simplifying the stockroom problem, lessening the dealer's investment, and facilitating the serviceman's work.
- The four RCA universal power transformers fit most sets from 4 to 12 tubes, including Class B service. List prices run from \$2.06 to \$6.50. The output transformer matches all output tubes, single or push-pull, and any dynamic speaker with a voice coil from 1 to 15 ohms. It is available for normal climates at \$1.95, or vacuum-impregnated in cadmium-plated can for tropical locations at \$2.42. All these transformers have suitable taps permitting accurate matching, and slotted brackets for easy installation. Ask your RCA Parts Distributor to put you on his list to receive the new catalog illustrating and describing all RCA parts and service specialties.



**RCA PARTS DIVISION**

RCA Manufacturing Co., Inc.  
Camden, New Jersey

## THE LIMIT OF AMPLIFICATION

(Continued from page 10)

at the terminals of a resistance R is  $V^2 = 4 k T R F$

where k is Boltzmann's gas constant, T is the temperature in degrees Kelvin, and F is the frequency band width in cycles per second. At room temperature 4kt has the value  $1.64 \times 10^{-20}$  when V is expressed in volts and R in ohms.

The noise in a thermionic vacuum tube arises from the fact that the space current is not a smooth flow of electricity but is subject to rapid and irregular fluctuations in magnitude. These are made manifest by voltage fluctuations across the external load impedance of the tube. Although the magnitude of this effect is small it may be heard as a roar at the output of a high-gain amplifier. While thermal noise in the circuit is accurately predictable, the noise originating in the vacuum tube is not completely understood and cannot be accurately calculated. It is known, however, that the noise arises from a number of different causes. Chief among these are: (1) "thermal agitation" in the internal plate resistance of the tube; (2) "shot effect" from the space current in the presence of space charge; and (3) "space charge fluctuations" due to positive ions.

Just as voltage fluctuations are produced by "thermal agitation" in the external circuits, so the internal plate resistance of the vacuum tube is a source of thermal noise. It has been deduced that this resistance produces thermal noise as if it were at the temperature of the cathode. This is the most fundamental source of noise in vacuum tubes and should set the limit in the ideal low-noise tube.

Positive ions emitted from the cathode or produced by ionization of the gas within the tube are very effective in producing fluctuations in the "space current" of an amplifier tube. While its own charge contributes little to the current, one ion may cause the current to change by an appreciable amount on account of the hundreds of electrons which are liberated by it in its flight through the space-charge region.

The performance, as regards freedom from noise, of a vacuum tube used in an amplifier may be indicated by a comparison between the noise and a signal applied to its grid. Usually we say, "the noise is equivalent to a signal which gives the same power dissipation in the output measuring instrument as the noise." A convenient signal for measuring purposes is the thermal noise voltage of a resistance placed between the grid and cathode of the tube under test. When this method is used neither standard oscillator nor calibrated amplifier is required.

Quantitative noise measurements have been made by this method on several different types of standard Western Electric vacuum tubes. To obtain the best signal-to-noise ratios it was found that operating conditions different from those normally recommended have to be used.

In general, the cathode must be operated at as high a temperature as possible without impairing the life of the tube, the negative bias of the control grid must be reduced to as near zero as possible without causing excessive grid current, and the plate and screen-grid voltages must be reduced below those values normally recommended. The measurements were made at voice frequencies, the effective band width being about 7,000 cycles per second. The results are given in Table I, both in terms of equivalent resistance Rg and the calculated root-mean-square tube noise voltage. A part of these data were taken by D. B. Penick. It is seen that the 102G triode has the lowest signal-to-noise ratio of all the tubes tested, requiring a signal of only 0.8-microvolts at its grid in order to equal the tube noise over this frequency range.

Noise as a function of frequency has been studied in four of the above types of tubes. The results are given in the graph where abscissas represent frequency in cycles per second, and ordinates represent tube noise in mean-square volts per cycle. (It can be seen that the noise is inversely proportional to frequency at low frequencies but remains relatively constant above 1,000 cycles per second.)

TABLE I

Tube Number	Type	Rg Ohms	Noise Microvolts
102G	Triode	3900	0.67
264B	Triode	7650	0.94
262A	Triode	7700	0.94
259B	Triode	19,800	1.41

## RADIO PICTORIAL

(Continued from page 9)

technique in playing. The top row of stops are "harmonic stops." A rear view of the amplifying and reproducing cabinet is shown at the right. Vacuum tubes are used for amplifying only and do not produce any of the tones. The heart of the instrument is shown directly below. On the extreme left may be seen the small synchronous motor, which rotates 91 tone-generating elements. Mounted directly over the motor is a preamplifier which builds up the tones before reaching the main amplifier above. Through this electrical operation, several important advantages are gained over the conventional pipe organ. The variety of tone coloring is practically infinite; total response of key and swell pedal is instantaneous; the swell pedal through its tremendous dynamic range is capable of great musical expression.

As pointed out above, the heart of the instrument is the electrical tone generator—see Fig. 1. It consists of a tone wheel, a permanent magnet and a coil wound around the permanent magnet. The tone wheel is about 2 ins. in diameter and is mounted on a shaft which is rotated continuously at a fixed speed. This wheel does not touch the magnet point; it merely passes close to it. Each time a high spot on the tone wheel passes the permanent magnet, a change of magnetism occurs which causes an electrical impulse to be induced in the coil, at the "bump frequency."

Four groups of "harmonic stops" at the top row of the console are seen in the illustration on page 9. In Fig. 2 is shown a single group of stops; each may assume one of 9 positions. As the stop is drawn out, the harmonic reaches its maximum strength at the position marked 8.

What happens when the stops are placed in various positions is graphically illustrated in Fig. 3. Here are the four fundamental families of tone. These tones are: (A) flute; (B) diapason—the fundamental tone of the organ; (C) string; and, (D) reed. (The note in each of the four cases is the International "A" of 440 cycles.)

The volume of the organ is controlled by the "swell unit," a foot operated bar at the base of the instrument. The dynamic range of the swell unit is stupendous. (Technically, the power ratio in this "electric" organ is 50 decibels; in the regular, "air" organ it seldom exceeds 15 decibels.)

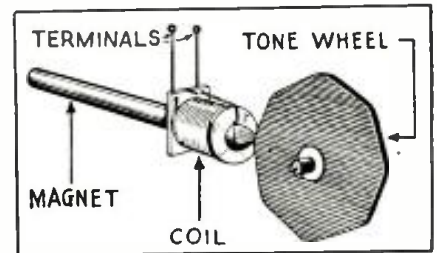

Fig. 1. The electrical tone generator.

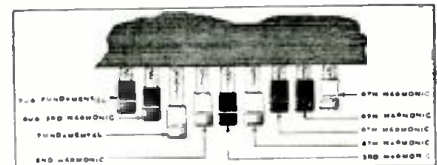

Fig. 2, above. The harmonic stops.

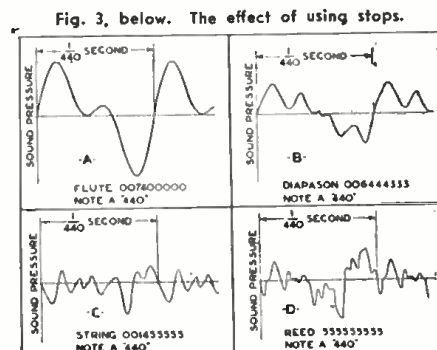

Fig. 3, below. The effect of using stops.

Please Say That You Saw It in RADIO-CRAFT



**ANNOUNCING — RADIO-CRAFT'S "IDEAL RADIO SERVICE SHOP" CONTEST \$400 IN PRIZES!**

(Continued from page 14)

**RULES OF THE CONTEST**

- (1) Simply write a letter of 300 words (or less) on the subject: "My Ideal Radio Service Shop."
- (2) The contest is open to all readers of RADIO-CRAFT (excepting the employees of the publishers and their relatives).
- (3) You need not own a service shop nor possess any of the equipment you describe.
- (4) No detailed technical description of the apparatus is required or desired, nor the names of the manufacturers.
- (5) Mention of elaborate testing equipment suitable only for exhibition use will detract from the value of the letter. The inclusion of useful, confidence-creating apparatus, however, is recommended.
- (6) Literary ability is not required. Anyone writing in understandable English, giving a good word description, has an equal opportunity of winning one of the valuable prizes.
- (7) Write only on one side; sign your name and address CLEARLY in the upper-right-hand corner; and number each sheet.
- (8) This contest begins on June 1, and will continue for 2½ months, closing on August 15. All contest letters must be post-marked not later than midnight, August 15, 1935.
- (9) RADIO-CRAFT reserves all rights to the use of the letters submitted to this contest.
- (10) Announcement of the first 25 letters eligible for the prizes will appear in the September, 1935, issue of RADIO-CRAFT. (If your name does not appear in this list, try again); announcement of the second batch of 25 "eligibles" will appear in the following October number; and announcement of the Awards to prize-winning contestants among these 50, and those who have made subsequent entries, will appear in the November, 1935, issue of RADIO-CRAFT. Awards will be shipped to the winners within 10 days after publication of the names. (Deliveries will be made either from RADIO-CRAFT offices, or directly from the manufacturer.)
- (11) To each of six contestants on the subscription records of RADIO-CRAFT by August 15, 1935, whose letters are adjudged best, will be awarded a volume of the 1000-page Official Radio Service Manual. This special award is an additional prize that does not have any effect on eligibility for a main prize. (In other words, it is possible to receive both a Consolidated Manual and a valuable Service instrument.)
- (12) Mail all contest letters to: Contest Director, "My Ideal Service Shop," RADIO-CRAFT, 99 Hudson Street, New York, N.Y.

**RADIO-CRAFT PRESENTS THE TRAVELING SERVICE SHOP**

(Continued from page 10)

than normally charged. After the shop is completed the first thing to do is to lay out the territory you will cover and make a definite schedule of stops. Have the schedule printed on cards and as you make the rounds be sure and leave cards at all available places, such as the general store, commissary, clubhouse, gas station, etc. Keep as close to the schedule as possible so that the customers can rely on your visits and therefore hold the work for your arrival.

The locations of vacation spots can be obtained from any travel bureau, gasoline company, railroad, social organization or fraternal society.

I defy the static. And any other interfering noises. Let 'em all come—whirrs, buzzes, screeches, man-made or other noises—anything that chafes your eardrums—I'll keep them out of your set!

**PERFECT EUROPEAN RECEPTION!**

Muter has met your doublet antenna problem—and solved it—with this new tuning device. It will couple a double antenna to your set—or any set—and it has switch control! This adapts it to all wave-lengths by a mere turn of the switch. The three taps adjust the antenna for QUIET European reception, efficient broadcast reception, or the sharpest possible tuning on any band. Think of the convenience! No need to disconnect wires. Just turn the switch. Any antenna but a doublet is obsolete—and any doublet without "Little Ajax" is just another aerial! With this coupler, your set will develop new tonal excellence and a quickened responsiveness. In addition to an unheard of fidelity and resonance, you will find your set increasing in efficiency and volume. More important than the improved reception, this coupler resists outside and man-made interference! It reduces static to an absolute minimum.

Get one from your jobber—or mail the coupon NOW and this All-Wave Tuning Coupler will be sent you at once, postage paid. Just pay the postman \$1.00 when it arrives. And, of course, it takes out all your reception troubles or your dollar will be immediately refunded.

Complete instructions for making the perfect doublet antenna system and attaching this coupler are included.



**THE MUTER COMPANY**  
1255F So. Michigan Ave.  
CHICAGO, ILLINOIS

**MAIL THIS COUPON!**

THE MUTER COMPANY  
1255F South Michigan Ave.  
Chicago, Illinois

Please RUSH me one of your All-Wave Tuning Couplers. I will pay the postman \$1.00. It must satisfy me in every way.

Name .....

Address .....

City ..... State .....

**WHAT DO YOU WANT TO KNOW ABOUT REFRIGERATION?**

If you are interested in servicing electric refrigerators, write GERNSBACH PUBLICATIONS, Inc., 99 HUDSON STREET, N.Y., for circular giving complete information on the OFFICIAL REFRIGERATION SERVICE MANUAL.

**Philadelphia RADIO TRADE SHOW**

Manufacturers and their representatives are invited to participate. The Philadelphia RADIO TRADE SHOW will be held during the week of July 8th. Write for complete details.

This gigantic radio show is sponsored by

**RADIO ELECTRIC SERVICE COMPANY**

Corner Seventh and Arch Sts.

Philadelphia, Penna.

Please Say That You Saw It in RADIO-CRAFT

# TECHNICIANS' DATA SERVICE

JOSEPH CALCATERRA DIRECTOR



Be Prepared  
to Test the  
NEW METAL TUBES

**T**HE tube situation has changed. Metal tubes are here! Will you be prepared to test the new Octal metal tubes when you are called upon to do so—or, will you have to tell your customer: "Sorry, Mr. Jones, my equipment is not capable of handling the new tubes."

Be prepared! See the new *Readrite* Model No. 430 Tube Tester . . . at your jobber's. It has been especially designed to handle every type of tube—both with metal or glass envelope . . . accurately and speedily. Constructed with sloping panel and removable cover for either counter or portable use.

The model No. 430 has five sockets, that are flush with the panel. One socket is equipped to test the new 8-Prong Octal metal tube. Another feature of this new tester is the shadow-type line voltage meter . . . located directly above the moving-coil type instrument used for testing Good and Bad tube values. Direct reading. Controls are simple and positive in action. This new all-type tube tester makes every inter-element short and leakage test, which is instantly convincing to the customer.

F. E. Wenger, Radio Engineer of the Readrite Meter Works, says: "The question of servicing the new type Octal metal tube is important to every service man. Readrite tube testers, now in service, can easily be adapted for the new Octal tubes."

Simply get in touch with your jobber, or communicate directly with the Readrite Meter Works for full information of this newest testing equipment.

## READRITE METER WORKS

161 College Ave. Bluffton, Ohio

## RUSH COUPON FOR DETAILS

Readrite Meter Works  
161 College Avenue  
Bluffton, Ohio

Gentlemen: Send me literature on your new Readrite Tube Tester No. 430.

Name .....

Street .....

City..... State.....

The literature listed in this department contains a wealth of very useful information.

A special arrangement between RADIO-CRAFT magazine and the publishers of this literature, which permits bulk mailings to interested RADIO-CRAFT readers, eliminates the trouble and expense of writing to each individual organization represented in this department.

2. HAMMARLUND 1935 CATALOG. Contains 12 pages of specifications, illustrations and prices on the new line of Hammarlund variable, mid-gate, band-spread and adjustable condensers; trimming and padding condensers; R.F. and I.F. transformers, coils and coil forms; sockets, shields, chokes and miscellaneous parts for ultra-short-wave, short-wave and broadcast operation.

3. HOW TO GET A HAMMARLUND 1935 SHORT-WAVE MANUAL. A circular containing a list of contents and description of the new 16-page Hammarlund Short-Wave Manual, which contains construction details, wiring diagrams, and list of parts of 12 of the most popular short-wave receivers of the year.

4. THE "COMET PRO" SHORT-WAVE SUPERHETERODYNES. Describes the outstanding features of the standard and crystal-type Hammarlund "Comet Pro" short-wave superheterodynes designed to meet the exacting demands of professional operators and advanced amateurs for a 15 to 250 meter code and phone receiver, but which can be adapted by anyone for laboratory, newspaper, police, airport and steamship use.

5. ELECTRAD 1935 VOLUME CONTROL AND RESISTOR CATALOG. Contains 12 pages of data on Electrad standard and replacement volume controls. Truvolt adjustable resistors, vitreous wire-wound fixed and adjustable resistors and voltage dividers, precision wire-wound non inductive resistors, center-tapped filament resistors, high-quality attenuators, power (50- and 150-watt) rheostats and other Electrad resistor specialties.

25. LYNCH NOISE-REDUCING ANTENNA SYSTEMS. Complete descriptions and instructions issued by Arthur H. Lynch, Inc., for making all kinds of antennas for broadcast and short-wave reception, with a special supplement covering Ham Antenna Design for transmitting as well as receiving on all the amateur bands, including the ultra-high frequencies.

26. LYNCH AUTO RADIO ANTENNAS, FILTERS AND NOISE SUPPRESSORS. This folder describes a complete line of Lynch antennas, filters and ignition noise suppressors designed for auto radio installations. The antenna system is of the under-the-car type for easy installation. It includes data on Hi-Gain matched-impedance transmission lines which make the under-car antenna highly desirable for use with the new "Turret-top" cars.

28. LYNCH SUPER-FILTASTATS FOR AUTO RADIO INSTALLATIONS. Describes and illustrates, with instructions for using, the new Lynch Super-Filtastats which do away with the need for suppressors in auto-radio installations, giving better performance in operation for both the car and radio set.

34. SERVICE MAN'S 1935 ELECTRAD REPLACEMENT VOLUME CONTROL GUIDE. A 52-page vest-pocket size booklet containing a revised, enlarged and complete list, in alphabetical order, of all old and new receivers showing model number, value of control in ohms and a recommended Electrad control for replacement purposes. Contains specifications and volume-control circuits for over 2,000 receiver models.

57. RIBBON MICROPHONES AND HOW TO USE THEM. Describes the principles and operating characteristics of the Amperite velocity microphones. Also gives a diagram of an excellent humless A.C. and battery-operated preamplifier.

62. SPRAYBERRY VOLTAGE TABLES. A folder and sample pages giving details of a new 300-page book, containing 1,500 "Voltage Tables" covering receivers manufactured from 1927 to date, published by Frank L. Sprayberry to simplify radio servicing.

64. SUPREME No. 385 AUTOMATIC TESTER. A technical bulletin giving details, circuits and features covering this new Supreme development designed to simplify radio servicing. In addition to the popular features of Supreme analyzers and tube testers it contains many direct-reading features which eliminate guess-work or necessity of referring to charts or tables.

65. SUPREME 1935 LINE OF TESTING INSTRUMENTS. A 20-page catalog which gives complete information on the entire Supreme line of testing instruments, including the new 5-in. Supreme fan-shape meter, the new Model 333 De Luxe and low-priced analyzers, the improved Model 35 tube tester, the Model 61 oscillator and the Model 180 precision multi-wave signal generator.

66. A SUPREME A.C.-D.C. TESTER WHICH CAN BE BUILT AT HOME AT LOW COST. Gives complete information about the Supreme 5-in. fan-shape meter, rectifier and resistor kit for the home construction of an inexpensive A.C.-D.C. tester.

67. PRACTICAL MECHANICS OF RADIO SERVICE. Information, including cost, features and outline of lessons of the Frank L. Sprayberry course in Radio Servicing, and list of Sprayberry Data Sheets for modernizing old radio equipment.

69. CASE RECORDS OF BROADCAST RECEIVER REPAIRS. Gives plan, contents and price of the Capitol Radio Research Laboratories' loose-leaf case records of 1,500 service jobs showing how actual troubles were corrected. Serves as a guide in correcting troubles in all types of receivers and power-supply units.

70. DATA SHEET ON BUILDING AN ANALYZER ADAPTER. Compiled by the Capitol Radio Research Laboratories to show Service Men how any analyzer may be brought up to date; or how to build a complete, modern analyzer out of spare parts and the use of only a multimeter.

72. HALLICRAFTERS' SKYRIDER SHORT-WAVE RECEIVERS. Descriptions of the Skyriders tuned R.F. and Super Skyriders superheterodyne short-wave (Continued on page 44)

### Radio-Craft Technicians' Data Service

99 Hudson Street, New York City, N.Y. RC-735

Please send to me, without charge or obligation, the catalogs, booklets, etc. the numbers of which I have circled below.

2	3	4	5	25	26	28
34	57	62	64	65	66	67
69	70	72	73	74	75	76

My radio connection is checked below:

- Service Man operating own business.
- Service Man for manufacturer.
- Service Man for jobber.
- Service Man for dealer.
- Service Man for servicing company.
- Dealer.
- Jobber.
- Experimenter.
- Professional Set Builder.
- Amateur Set Builder.
- Licensed Amateur.
- Station Operator.
- Radio Engineer.
- Laboratory Technician.
- Public Address Worker.
- Manufacturer's Executive.
- Student.
- .....

I am a:  
 Subscriber  Newsstand reader

I buy approximately \$.....of radio material a month. (Please answer without exaggeration or not at all.)

Name.....

Address.....

City..... State.....

(Please print name and address)

Avoid delay. The catalogs and booklets listed are now in stock and will be sent promptly as long as the supply lasts.

Please Say That You Saw It in RADIO-CRAFT



## THE LATEST RADIO EQUIPMENT

(Continued from page 12)

### VELOCITY-MIKE HUMLESS PRE-AMPLIFIER (737)

(The Amperite Co.)

THE increasing popularity of the velocity microphone has created a demand for an inexpensive humless A.C. preamplifier. The gain of 59 db. in the 2-section unit illustrated brings the level of the "mikes" up to minus 25 db. The frequency characteristic is flat from 60 to 10,000 cycles.

### DIRECTIONAL BAFFLE (738)

(Macy Engineering Co.)

USE of all-metal aluminum baffles in order to secure more even sound distribution, and to effectively reduce bothersome feed-back difficulties has been found to increase cone speaker efficiency as much as 40 per cent. The model illustrated (available in all types) is weather-proof, light in weight and absolutely free from any metallic resonance conditions.

### REPLACEMENT SPEAKERS (739)

A NEW line of replacement speakers for dealers and Service Men. In four sizes: 5, 6, 8, and 11 inches. Attractive silver finish and of particularly sturdy construction; made with reinforced voice-coil. New features include: ease of voice-coil adjustment, patented waveform spider, diaphragm of high quality acoustic material. Output power ratings: 4 to 15 watts.

### NEW-DESIGN CONDENSERS (740)

A NEWLY designed paper dielectric tubular condenser is now available for Service Men. It is made with metal end discs to provide a path for quick radiation of iron heat. This prevents opens.

### MAGNETIZER FOR PICKUP MAGNETS (741)

(RCA Mfg. Company)

SERVICE Men should welcome this piece of auxiliary desk equipment. It is a battery-energized electro-magnet, powerful enough to

re-magnetize pickup polepieces and similar small magnets in from 1 to 2 seconds. It is of sturdy construction, designed to work with a 6 V. storage battery.

### BATTERY-CELL TESTER (742)

A NEW battery-cell tester, featuring a special switch which permits the instrument to be used either for the usual high-rate-discharge tests or for open circuit tests, has just been announced. The body of the tester is formed by a molded prod-handle shaped to fit the hand of the operator. A large, easily-read meter located at the top of the handle contains the usual voltage scale.

### SPECIAL ALLOY TRANS. CASTINGS (743)

(Alloy Transformer Co.)

SPECIAL high-permeability alloy castings are now available for all radio and P.A. men, for use in preamplifiers. The castings can be obtained in various sizes. They are the most effective shields against hum, as well as against all other A.F. disturbances.

### CALIBRATED ALL-WAVE SIGNAL GENERATOR (744)

THIS completely shielded and filtered instrument for aligning any radio set on intermediate, broadcast and short-wave frequencies is battery operated. Equipped with a vernier for "flat topping" intermediate stages. Range: from 100 to 13,000 kc., without the use of harmonics.

### CABINET REFINISHING KIT (745)

(RCA Manufacturing Co.)

THE wide-awake Service Man will carry a cabinet refinishing kit with him at all times to help him earn some extra money. The kit illustrated contains enough material to do most every job.

### ALL-WAVE COUPLER (746)

(The Muter Co.)

THE Muter Tuning Coupler is an all-wave device that is equally efficient on both the short-wave bands and the broadcast band. A switch makes the changeover.

## "THAT SYLVANIA MANUAL IS SWELL

... glad I bought it"



Take a tip from this radio man . . . send for your copy of this handy service booklet today . . . . .

● It costs just a dime for this valuable booklet. It's crammed with information useful to every radio service man. 35,000 have sent for it already and a lot of them have written in to tell us they're glad they clipped this coupon!

Sylvania has compiled this book for service men . . . men who know radios, but who are always ready to learn more about them. 104 pages of information about tubes . . . descriptions of them, with complete circuit applications. Helps you recognize actual problems that you might run into any day . . . and helps you solve them.

Don't wait . . . send your dime with this coupon today, and you'll see for yourself what a gold mine of information this Sylvania service manual is.

Hygrade Sylvania Corporation. Makers of Sylvania Tubes, Hygrade Lamps. Factories at Emporium, Pa., Salem, Mass., and St. Mary's, Pa.

# Sylvania

THE SET-TESTED RADIO TUBE

### 10c-TECHNICAL MANUAL-10c

Hygrade Sylvania Corporation, Emporium, Pennsylvania. (B-24)

Please send me the new Sylvania Technical Manual. I enclose 10 cents in stamps.

Name .....

Address .....

City ..... State.....



Replacement Reproducer. (739)

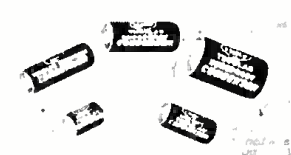

Above.—Unique condensers. (740)

Below.—Pickup magnetizer. (741)

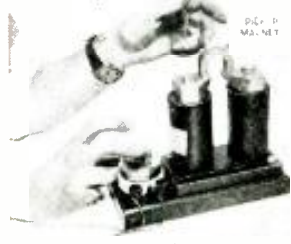

Above.—This battery cell tester contains a switch. (742)

Below.—A calibrated all-wave oscillator for set aligning. (744)

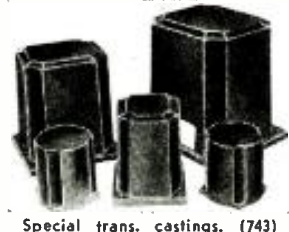

Special trans. castings. (743)



Above.—Refinishing Kit. (745)

Below.—Antenna coupler. (746)



Please Say That You Saw It in RADIO-CRAFT



## Here's a Troupe that "Wows" 'Em!

Four husky boys, these, that have been on most of the world's best circuits.

Fathered by old man Radiohm himself, he and his three sons, Kid Suppressor, Kid Resistor and the new member of the team, Big Boy Sound Projection Control, are in the spot light of popularity with servicemen and experimenters everywhere.

How these boys can work! It's a pleasure to watch 'em . . . smooth, efficient, noiseless and each performance as reliable as the next.

Note: Mr. Trouble Shooter . . . stock up with Centralab Replacement parts . . . the cheapest in the long run.

## Centralab

Division of Globe-Union Mfg. Co.  
MILWAUKEE, WIS.

RADIOHMS SUPPRESSORS  
RESISTORS

## DEMOUNTABLE CRYSTAL MICROPHONE

Instantly installed on stand! Instantly removable for safe-keeping or use elsewhere!

**Shure Model 70H-79A Demountable Crystal Microphone** is a complete unit, with a high-quality diaphragm-type crystal microphone head. Due to exclusive Shure "Cantilever" principle, the frequency characteristic is excellent and the output level is unusually high. **\$27.50**  
List price . . . . .

**Shure Model 70H Crystal Microphone.** With out demountable adapter. **\$22.50**  
List price . . . . .

Bullet, Studio and Desk-Type models, complete with associated preamplifier, are also available.



**See your Jobber for complete details.** Licensed under patents of the Brush Development Company.

**SHURE BROTHERS COMPANY**  
Manufacturers of Microphone Headquarters  
215 WEST HURON ST. CHICAGO, ILLINOIS

## THE RADIO SERVICE BUSINESS

(Continued from page 13)

upon which a profitable radio service can be erected. There is no doubt that the "ought to be" Service Men will disappear without any official regulations when the new and very tricky all-wave sets appear for which Ohm's law alone does not give the opening key.

### SOMETHING FOR MR. PRICE-CUTTER

There is now much despair, starvation and sadness among radio Service Men, because there are too many of them, and because they undersell one another. Service Men who cut prices are "radio chiselers" and not Service Men. A radio Service Man is only a skilled worker, who asks for a just price, regardless of how high or how low it might be, and one who gives the customer fair value. With free inspection, or a 50 cent service, it is impossible to make a living. Why not return to the customer the defective parts, and mark the installed one with a red dot? Since it is often impossible to make an accurate estimation of how much a repair job might cost at first glance, a customer receiving his old parts would naturally show more willingness to pay the additional amount if it is necessary.

### HOW MUCH TO CHARGE

The sales promotion manager of the RCA Manufacturing Co., T. F. Jones, who should know how to direct a business, recently gave the answer to the question: How much to charge?—"The Service Man should charge according to the value of the job. It is important to be fair to all concerned and not only to charge for time used to fix the receiver but also to charge for the experience and knowledge involved." However this does not mean that the customer should pay for overtime due to lack of knowledge, because the customer is entitled to a fair return for a given expenditure. On the other hand it also means that a skilled worker with experience is only entitled to the value of actual time spent on the set, since nobody would refuse to pay the full doctor bill in the case of a consultation which only lasted a few minutes, as long as the visit was of help to the patient.

### SERVICE MEN DETERMINE YOUR COST

C. J. Benedict recently collected facts concerning the cost of seven Cleveland servicing organizations, and published them in RADIO RETAILING. These facts are, of course, not fundamental, since expenses are variable in different communities. This defect is counterbalanced, however, by the fact that seven different service organizations are included—small operators as well as larger ones.

TABLE I

Average expenses per year.		
a) fixed expenses		
Rent	\$ 154.00	
Light, power	46.65	
Heat	33.37	
Garage	43.20	
Dues	8.57	
Telephone (shop use)	64.00	
Car license	7.68	
Shop insurance	4.56	
Car insurance	4.31	
Other insurance	2.68	
Magazines	5.21	
Manuals	8.57	
Other service data	4.17	
Depreciation on car	79.00	
Depreciation on tools	7.96	
Depreciation on instruments	61.00	
Depreciation on fixtures	12.50	
Interest on investment	29.50	
Salary helper	478.00	
Salary owner	1,386.00	
	\$2,440.93	2,440.93
b) variable expenses		
Circulars	\$ 11.45	
Stickers	2.32	
Advertising	19.72	
Signs	7.94	
Postage	14.93	
Stationery	17.93	
Telephone (for sales)	34.50	
Repair on car	40.56	
Tires	21.50	
Gas and oil	104.00	
General shop supplies	51.40	

Miscellaneous (office)	5.93	
	\$ 332.14	332.18
		\$2,773.11

### 2 DOLLARS PER HOUR?

This table shows that about \$2,800 is the average cost per year. Since there are really only 300 working days in the year, 2,400 working hours may be figured. Subtracting 100 hours for summertime, etc., an average of 2,000 hours remain. The average cost for a service organization, includes \$1,386 salary for the owner (equal to a weekly average of about \$26) which is low for a shop owner having considerable responsibility.

These figures show that the cost per hour is 2.800

2,000 or \$1.40. Since this sum does not take in account unforeseen expenses the cost per hour might be around \$1.50. There is also some profit through the replacement parts discount. However, as experience shows, many customers are well informed of replacement prices through catalogs received from radio mail order houses. Further, it is necessary to keep in mind the fact that loss of time and money occurs through ordering and buying these parts, (telephone expenses and mail charges, etc.). The real profit is therefore much smaller than is often estimated. But let's be generous and consider a profit of about \$200 per year as granted, by basing the entire business volume at about \$5,000 per year. The remaining \$200 are, of course, not sufficient to let the Service Man grow up into a position of a millionaire, if he charges \$1.50 per hour. It would be easy to say: "charge \$2.00 per hour," if there were no competition, but since the average charge is lower than \$2.00, how is the Service Man to make a decent living, and to accumulate a reserve for "rainy days"?

### DOES ADVERTISING HELP?

To obtain more work we first have to make a survey of the actual market. If there are only 5,000 sets within the service area of an organization, experience shows that not more than 1,500 sets will be serviced during a year. In other words a business volume of about \$5,000 may be obtained under such circumstances. Very often the number of sets is much larger but competition must also be considered. Since underselling is not the right way to make a living, attention to your service shop has to be called by advertising. Newspaper advertising, though often tried, does not seem to pay, because people do not think about radio service until their radio set stops, and usually the radio listener will look up the classified telephone directory for the nearest repair shop.

### "AID" TO SHOP OWNER

Another possibility for a very effective advertising without heavy cost is to ask owners of vacant stores for the use of their show windows free of charge, by using the true argument that a constantly cleaned window, containing some display, keeps the store more presentable for the eventual appearance of a tenant. The necessary display material may be obtained without expense from tube manufacturers. A collection of parts, with some remarks, in slogan form, about wasted money, and poor reception due to electrical leakage by condensers, obsolete tubes, etc., will help more than anyone would expect.

### POSTERS AND PENNY CARDS VERY EFFICIENT

Repaired sets should be furnished with a small sticker containing the address and the phone number of the service shop. Similar posters should be posted upon each replacement tube sold. Old customers should receive at least one card a year in which the Service Man thanks him for the interest in his organization.

### UTILIZATION OF OTHER POSSIBILITIES

Leaflets thrown in parked cars—which have an auto radio set—with advertising for a "battery booster" to compensate for the additional battery drainage through the radio set will bring some returns. Remarks made "just by accident" when returning the repaired set that a second speaker (a so-called tweeter) would improve the performance, might promote some additional business.

Please Say That You Saw It in RADIO-CRAFT



## HOW TO MAKE A PERPETUAL ANALYZER PANEL

(Continued from page 15)

can be omitted by using individual shunts for each range.

Switch No. 6 is the A.C. range selector, which also selects two output ranges, resistance continuity, and two ranges of capacity tests. Toggle switch No. 12 has the same function as No. 11 and must be used when alternating currents of more than 1 ma. are measured, since a series shunt is used.

All switches thus far described have an off position to which they must be turned when not in use.

Switch No. 13 is a double-pole single-throw toggle switch which connects the 120 V. 60 cycle A.C. supply for capacity measurements.

The voltages of the various tube elements may be taken from cathode, filament, or ground by putting switch No. 10 in proper position. This is a single-pole triple-throw toggle switch. A connection between ground tip-jack and chassis of set under test must be made when taking ground potentials.

Switch No. 7 is the A.C.-D.C. switch that must be in position for whatever readings are being taken. To it switch No. 8 is mechanically coupled and closes when in the A.C. position.

Switch No. 9 is the reversing switch that reverses the polarity of the meter. It is a double-pole double-throw toggle switch. It will only be used occasionally, since all connections are made so that the meter is straight reading.

The ohmmeter zero adjuster is a potentiometer of 500 ohms that must have an off position in which it is left when making tube tests, otherwise the negative side of the meter will be connected to the grid of the tube through R5. The capacity meter adjuster is about 750 ohms and must be able to carry 80-100 ma.

Individual four-, five-, six-, and seven-prong sockets are used since the writer thinks the combination sockets are very confusing; although the seven-prong socket is of such type as to take both small and large tube bases.

### LIST OF PARTS

- One A.C.-D.C. meter 0-1 ma., 100 ohms;
- One switch built according to Fig. 2, Sw1;
- One two-deck 10-point rotary switch, Sw2;
- Three single-deck 10-point rotary switches, Sw3, Sw5, Sw6;
- One two-deck 6-point rotary switch, Sw4;
- One three-pole double-throw jack switch, Sw7;
- One D.P.-D.T. toggle switch, Sw9;
- One S.P.-triple-throw toggle switch, Sw10;
- Two S.P.-S.T. toggle switches, Sw11-Sw12;
- One D.P.-S.T. toggle switch for capacity measurement line switch, Sw13;
- One locking-type push-button, PB;
- One 500 ohm rheostat with off position for ohmmeter adjuster, R1;
- One 750 ohm rheostat with off position for capacity meter adjuster, R2;
- Four sockets 4, 5, 6 and 7 prong;
- Four adapters from small 7 to large 7 to 6, 5, and 4 prongs;
- One small 7-prong plug;
- One 8- or 10-pole plug and socket;
- Five ft. of 8 wire analyzer cable.
- Three ohmmeter resistors 30.3, 333.3, and 2,916 ohms.
- One set of shunt and multiplier resistors as indicated in diagram;
- (If very accurate readings are required, complete precision shunt and multiplier resistor sets specially made for the instrument are easily obtainable, and must be used.)
- One 6-volt pilot light in series with a 20 W. 800 ohm resistor;
- One 4.5 V. battery;
- One .1-mf. mica condenser, C1.

The appearance of the analyzer panel.

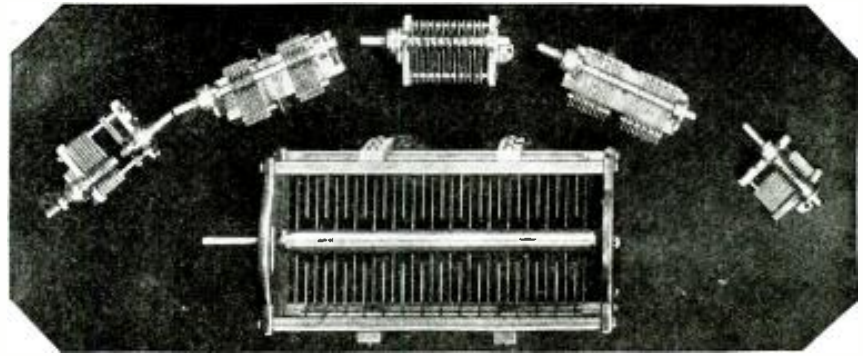
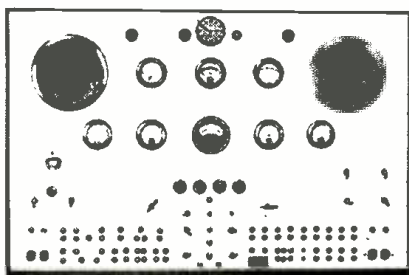

## HAMMARLUND CONDENSERS

Made in  
**18 TYPES**  
For Every Radio  
Purpose

**W**HATEVER your condenser need may be—for transmitting, receiving, trimming, balancing, padding, antenna tuning, etc.—Hammarlund makes it in the required capacity rating.

Eighteen different types for every radio purpose—priced at 30 cents to \$18.00 list.

And as to **QUALITY**—practically every amateur and professional operator, and every radio manufacturer throughout the world, since 1910, has respected Hammarlund prestige.

But *talk* is not *proof*. Put Hammarlund Condensers to the severest tests and let *experience* demonstrate how greatly they improve the performance of any circuit.

Write Dept. RC-7 for Details.

Hammarlund Manufacturing Co.,   
424-438 W. 33rd St., New York



**Now!** A Universal Condenser Tester  
Checks Leakage and Measures Capacity  
in the Same Instrument!



Build It Yourself

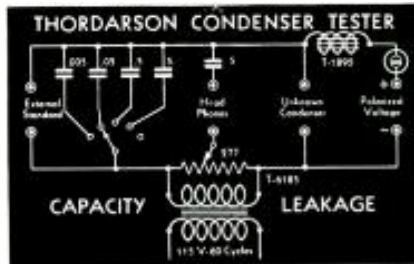

Easy to assemble, using the THORDARSON FOUNDATION UNIT Consisting of:  
1. A Portable Walnut Instrument Case.  
2. An Etched and Drilled Metal Panel.  
3. Complete Instructions and Plans for Assembly.

ORDER FROM YOUR THORDARSON

JOBBER!

List Price \$4.50, subject to regular trade discounts.  
All parts required are standard items. Perhaps you have most of them on hand!

Observe the simplicity of the circuit! Read capacity in microfarads and detect leakage up to 2 megohms. For 60 cycle, 110 volt A.C. operation.

Send 10c for the Servicemen's Guide and complete parts list of the THORDARSON Condenser Capacity and Leakage Tester.

# THORDARSON

Electric Mfg. Company

502 W. Huron Street

Chicago, Ill.

Please Say That You Saw It in RADIO-CRAFT

# PUBLIC ADDRESS PAYS PROFITS

A Horn and Speaker

Model 2050  
(formerly Model 3500)  
6 to 500 volts  
field coil

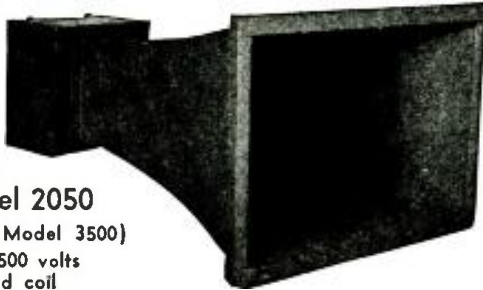

for only  
**\$20<sup>50</sup>**  
List

## Good, Clear, Quality Reproduction

"Sound" with its many branches is fast becoming the greatest and most profitable business in the electrical world. Where there is good sound there you will find Wright-DeCoster Speakers.

Write for complete catalog, dealer's discount and name of our nearest distributor.

Wright-DeCoster distributors will co-operate with you in every way possible.

**WRIGHT-DECOSTER, INC.** 2251 University Ave., St. Paul, Minn.  
Export Dept.—M. Simons & Son Co. Cable Address: SIMONTRICE, New York

## PRACTICAL METHODS OF SERVICING "NOISE"

(Continued from page 18)

By varying the arm setting on potentiometer R1, which is 400 ohms, the correct zero setting may be obtained upon the V.-T. voltmeter, which must be the axis for zero reading when no interference is received, or very little when the interference is being picked up. At this point there should be no deflection on the plate current milliammeter. *Caution:* One should not operate the V.-T. voltmeter as shown here from the same batteries which serve the receiver.

When using this device, the closer one comes to the point of interference, the greater will be the meter deflection.

When using a head-set with this receiver, it is advisable to connect any standard "output" meter across the output of the receiver.

For the work on any single frequency, the simple type of resistance control shown in Fig. 1D is most appropriate.

In Fig. 1D, R1 and R2 are the two resistances. Resistor R1 is used to shunt the headphones, and R2 is the compensating resistance. As R1 decreases, R2 increases. Therefore,  $K = \frac{Res + Zt}{Res}$ , in which K is the audibility con-

stant on the scale of the audibility meter. R2 is the effective shunt resistance value R1-R2, in shunt with the section, and Zt is the telephone receiver impedance.

Another inexpensive outfit may comprise a superheterodyne the output of which goes through an A.F. power amplifier. The output of the power amplifier is again rectified by means of a vacuum tube, and then passed through an Esterline-Angus recording milliammeter, which requires approximately 10 ma. for full-scale deflection. Here the field and armature may be connected in series, or, if one wishes, the field may be excited by means of an external battery. But due to the fact that the amplifier is furnished with "B" power, this supply may readily be used to energize the field circuit for the meter.

The chart on the meter should be speeded up somewhat. Instead of  $\frac{3}{4}$ -in. per hour, the rate should be increased to 6 ins. hourly. Thus (when the speed is increased) there will not be a solid mass of ink-daubing on the chart. At the end of an hour (or any desired period) by visualization and by auditory means, we have the exact facts which bring the interference to our attention. By this comparison, we may devise a means of locating the interference.

Another simple means of locating interference may be carried out by taking a transformer and using a crystal detector with a galvanometer in series, as shown in Fig. 1E. The impulse of electrical energy, which becomes rectified, will cause the galvanometer needle to deflect, thus giving us a visual appearance of the intensity of electrical energy.

(Part II will discuss practical procedure in locating all types of interference—or "noise" as the average set owner is wont to call the miscellaneous clicks, rattles and bangs that emanate from his set reproducer.)

## SHORT CUTS IN RADIO

(Continued from page 17)

find that the buzz helps for I can listen to it and go on with other work.

R. S. MALLORY

## HONORABLE MENTION

**A**N INTERFERENCE TROUBLE FINDER. Many auto-radio sets, such as the Transitone No. 9 are used to locate power leaks and radio interference.

The operation for this purpose is improved if the A.V.C. is disconnected. This can be done by providing a switch as shown in Fig. 9.

R. T. PENTZ.

## HONORABLE MENTION

**A** GRIP FOR SCREWDRIVER HANDLE. Here is a little make-shift for the screwdriver to help to turn it in inaccessible places. (See Fig. 10). Wrap a mason jar rubber tightly around the handle and secure it with a piece of string.

FRANK W. BENTLEY, JR.

## TECHNICIANS' DATA SERVICE

(Continued from page 40)

receivers designed and built by Hallicrafters, Inc. Features: range of 13 to 200 meters (with broadcast or 10-meter band optional), automatic wave-change switch, continuous band-spread, built-in monitor, speaker and power supply (or batteries), high-fidelity audio, and other refinements.

73. HETRO HOME AND AUTO-RADIO RECEIVERS AND ACCESSORIES. A folder containing descriptions, illustrations, list and net prices of the Hetro Electrical Industries, line of console, phono-radio and table-model home radio receivers, auto-radio sets, phonograph automatic record changers and motors, antenna systems and D.C. converters.

74. SPRAGUE 1935 ELECTROLYTIC AND PAPER CONDENSER CATALOG. Gives specifications, with list and net prices on a complete line of wet and dry electrolytic, and paper condensers made by the Sprague Products Co. for radio Service Men, set builders, experimenters and engineers. Information on the Sprague Capacity Indicator, for making capacity tests on condensers and in servicing receivers, is included.

75. SPRAGUE TEL-U-HOW CONDENSER GUIDE. A valuable chart, compiled by the Sprague Products Co. which tells the proper types, capacity values and voltages of condensers required in the various circuits of radio receivers and amplifiers, and how to locate radio troubles due to defective condensers. Includes data on condenser calculations.

76. FACTS YOU SHOULD KNOW ABOUT CONDENSERS. A folder, prepared by the Sprague Products Co., which explains the importance of various characteristics of condensers, such as power-factor, leakage, capacity and voltage in determining the efficiency or suitability of a given condenser to provide maximum filtering and safety in operation.

## INTERNATIONAL RADIO REVIEW

(Continued from page 11)

type used by manufacturers can be readily clamped in it. The enterprising Service Man can easily make a frame of this type and it will be found well worth the trouble.

Please Say That You Saw It in RADIO-CRAFT

## BUILD THE NEW THORDARSON CONDENSER TESTER



ALLIED is first with the new Thordarson Condenser Tester Kit described in "Radio Craft." Build this efficient, inexpensive test instrument. Combines efficient leakage tester with a bridge method of balancing the reactance of one condenser against another for a comparative measurement. Quickly and accurately measures capacity and indicates leakage and shorts in filter and by-pass condensers. Has many other applications. An invaluable test instrument for every radio serviceman. Easy to assemble; low in price. Write for FREE diagram, parts list, and description.

## ALLIED RADIO CORPORATION

833 W. JACKSON BLVD.  
CHICAGO, ILL. Dept. D.

Send me FREE Diagram and Parts List for building the Thordarson Condenser Tester.

Name.....

Address.....

## SOLAR AUTO RADIO CONDENSERS

Always reliable; meet the most exacting requirements of radio use. Fully withstand unusual conditions of heat and vibration. Complete line of standard and special types.



★ OIL-IMPREGNATED VIBRATOR CONDENSERS

★ SUPPRESSOR CONDENSERS

★ DOME LIGHT FILTERS



Write for latest Service Catalog No. 6-S  
Solar Manufacturing Corp., 599-601 Broadway, New York, U.S.A.

## SERVICE MEN

BUILD THE NEW THORDARSON CONDENSER CAPACITY AND LEAKAGE TESTER

Complete Kit of parts in stock VIBRATOR "B" TEST BOARD AS FEATURED IN JUNE RADIO CRAFT COMPLETE KITS IN STOCK

M & H SPORTING GOODS CO. 512 Market St. Philadelphia, Pa.





## Radio Men—hundreds of NEW SERVICING IDEAS



### "CASE RECORDS Of Broadcast Receiver Repairs"

Here are 1,500 actual service jobs—each a successfully completed service job. Alphabetically and numerically indexed, this service data in all covers 3,000 models of 108 set manufacturers. (One week's use of "CASE RECORDS" adds years to servicing experience.)

**\$4.75**  
POSTPAID

Planned Service Work, as you find in "CASE RECORDS" eliminates guesswork—adds speed to servicing jobs and more profits. The only volume which actually does the job for you. Bound in convenient, 9 x 12 inch loose-leaf binder . . . with FREE SUPPLEMENTS "ISSUED" QUARTERLY FOR A YEAR.

Order your Manual now . . . receive 1st Supplement with your copy of "CASE RECORDS" . . . in addition you receive FREE, the "CRRL" Data Sheet on "Building an Analyzer Adapter." USE COUPON BELOW.

CAPITOL RADIO RESEARCH LABORATORIES, INC.  
H. K. Bradford, President  
704 National Press Bldg., Washington, D. C.  
Capitol Radio Research Laboratories, Inc. RC-7  
704 National Press Bldg., Washington, D. C.  
Enclosed find my remittance of \$4.75 (check or money order accepted) for which send me, POSTAGE PREPAID, One Copy of "CASE RECORDS OF BROADCAST RECEIVER REPAIRS," also send FREE, the "CRRL" Data Sheet on "Building an Analyzer Adapter."  
Name \_\_\_\_\_  
Address \_\_\_\_\_  
City \_\_\_\_\_  
(Purchase price of Manual refunded if returned within 10 days)

## MARLO PRESENTS A COMPLETE 15 WATT SOUND SYSTEM

That Cannot Be Dupli-  
cated at Twice the Price.

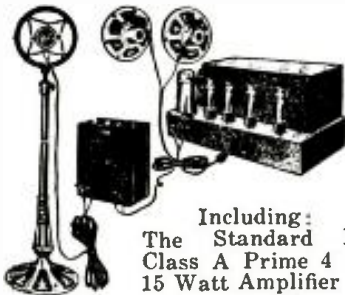

- Including:  
The Standard Marlo  
Class A Prime 4 Stage  
15 Watt Amplifier
- 2 11-inch heavy duty super dynamic reproducers.
  - 1 Standard large size chromium plated double button microphone
  - 1 Beautiful full length adjustable floor stand.
  - 1 Complete microphone input "mixer" stage for remote control operation.

Price Complete **\$41.95** Less  
As Illustrated **\$1.95** Tubes

**MARLO RADIO PRODUCTS**  
16 HUDSON ST. New York City

## FREE



**IMPORTANT ILLUSTRATED BUYING GUIDE FOR RADIO EXPERIMENTERS, SERVICE MEN, AND SHORT-WAVE FANS.—32 Pages—Two Colors—Profusely Illustrated This Book Will Save You Money!** Packed between the covers of this 32-page book is a tremendous array of modern radio equipment and other electrical and scientific merchandise—the very material for which you have been looking—and at prices which cannot possibly be any lower. Radio sets and parts, low priced microscopes, jeweled compasses, complete public address equipment, field glasses, the finest short-wave equipment available, crystal receivers, radio replacement parts, etc. Name the item—and it's in the book! This amazing book will show you how to save money. You save by buying at the lowest possible prices. Why not start saving now? Don't delay! Write today! Send postcard or letter blank by return mail. It's free!

**RADIO TRADING CO., 97 Hudson St. New York City**

## NEW DEVELOPMENTS IN CONDENSER CAPACITY AND LEAKAGE TESTERS

(Continued from page 20)

by a small filament transformer type T6185. A pair of phones is used to indicate the position of balance of the bridge. (Details of routine testing are discussed in reference to Fig. 1.)

The circuit diagram of the unit (Fig. 2) is self-explanatory. The parts should be mounted in the positions indicated on the instruction sheet furnished with the foundation unit, and all wiring completed. Care should be taken that the condensers are connected to the proper terminals of the range switch. When the latter is rotated to the ratio position, which is the outer scale, no condenser is connected in the circuit. Rotating the switch clockwise, the next step connects the 5 mf. condensers, and in rotation, .5-mf., .05-mf. and on the inner scale, .005-mf. After wiring, the phones should be connected and the primary of the filament transformer attached to the line. A pair of resistors of equal size should be connected, one to the "Test" terminals, and the other to the "External Standard" posts. The shaft of the potentiometer should now be rotated until the point where hum practically disappears is found. This is called the "null point." The bar knob should now be attached with the pointer exactly on the "1" mark of the outer scale, being careful not to disturb the setting of the potentiometer. For a check, the two resistors should be interchanged. If the "null point" is not still at "1" after the interchange of resistors, they are unequal. In this case the pointer should be set half-way between the two points if the difference is not too great. The scale is calibrated for the Ekestrad No. 277 potentiometer, and if another type is used, the calibration will, undoubtedly, be in error, due to difference in total degrees of rotation, as well as variation in resistance.

The routine for quickly testing condensers is as follows: referring to Fig. 1, which represents a typical rectifier and filter circuit, the positive terminal of the condenser to be tested is disconnected from the circuit at the point "X." Point 1 is connected to the (+) Polarizing Voltage terminal; 2 is connected to the (+) Test; and 3 is connected to (—) Test. It is not necessary to make a connection to (—) Polarizing Voltage unless this voltage is secured from some other source, such as "B" batteries or a separate power pack, since (—) Test and (—) Polarizing Voltage are connected together within the unit.

If the condenser under test is not shorted or leaky, the capacity may be measured by rotating the bar knob until the position of minimum hum, known as the "null point," is located. The range switch must, of course, be in the correct position. If the condenser is open it will be impossible to balance the bridge, and the least hum will be heard when the pointer is rotated to the left as far as it will go.

The impedance of the voice coil of a speaker, at 60 cycles may be measured by connecting it across the test posts and a resistor of ten ohms or so across the "External Standard" posts. The ratio is read when the bridge is balanced. If an audio oscillator is available, the impedance may be measured at various frequencies by connecting the output of the oscillator to the primary of the filament transformer. The field of the speaker should be energized while the measurements are being taken.

There are so many applications for the unit that it is impossible to suggest them all, but the Service Man will find this to be one of the most valuable instruments on his test bench.

Fig. 2—The circuit of the tester.

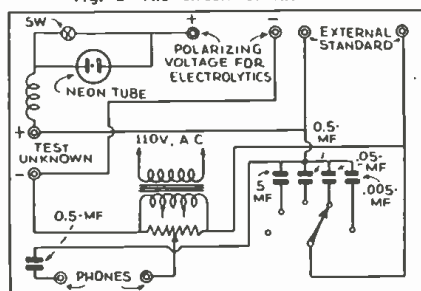

## HOW TO OBTAIN HIGH FIDELITY

(Continued from page 20)

cause of drummy and muddled tones in transformer coupled stages, as the condenser C1 tunes the transformer to some fixed frequency and causes harmonic distortion at that point.

In many early receivers and amplifiers, the mere introduction of the additional bypass and filter condensers greatly enhances the low frequency tonal response, and eliminates some of the harmonic distortion otherwise present. Where it is desired to rid a unit of some of the low-frequency range without introducing harmonics, a simple circuit shown in Fig. 1B may be employed.

### HIGH FIDELITY

The above tone controls are only palliatives at their best, and remedy only undesirable conditions, by flattening out the overall response curves as shown in Fig. 3.

However, in order to obtain high-fidelity reproduction, it is not only necessary that the response curve be absolutely flat, but that it extend all the way down to 40 cycles and all the way up to 15,000 cycles. Now the extremely low and high frequencies are usually present to a certain extent, and therefore the problem becomes one of increasing the response curve at these frequency bands. It is certainly surprising that although the various telephone companies have employed such procedures daily for many years, few other people avail themselves of these facilities. A very simple method of attaining this end consists in the use of a series tuned circuit shown in Fig. 4 consisting of a condenser C2, and inductor L2 and a resistance R5, chosen in such a way, as to reduce the overall amplification of the amplifier or radio receiver in question for all frequencies ranging from about 400 to 5,000 cycles, and thereby automatically increasing the relative response below 400 cycles and above 5,000 cycles.

Fig. 4A illustrates the frequency response of many radio receivers or power amplifiers. Note the sloping off of the curve at both the low and the high frequencies. Fig. 4B gives the impedance in ohms of a series circuit consisting of a resistor, a condenser and an inductor in series. The broadening and flattening out of the overall response curve—constitutes a close approach to high-fidelity amplification, is shown in Fig. 4C. Note that the fixed resistor R5 may be replaced by a rheostat, permitting thereby a gradual control of the response curve.

Identical results may be obtained with push-pull amplification by employing two resistors R5, two condensers C2 and a center tapped inductor L3. This is shown in Fig. 5.

The equalizers above described are known as series equalizers, and are the most efficient type known. Another type of equalizer commonly encountered, and also producing a high-fidelity type response curve, is shown in Fig. 6. They operate on the absorption principle, and are used essentially in conjunction with A.F. transformers. They partially short out the frequency band extending from about 400 to 5,000 cycles, and produce thereby the same net results as the series equalizers, above described.

These various equalizers, namely the parallel and the series type, are completely self contained in high permeability castings of a relatively small size, measuring only 2 by 2 by 2 1/2 inches.

Fig. 5—The application to P.P. units.

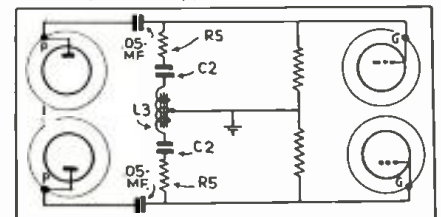
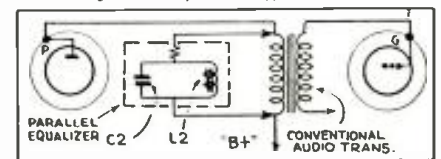

Fig. 6—The parallel type of filter.



Please Say That You Saw It in RADIO-CRAFT



## HOW TO MAKE A SPEAKER FIELD SUPPLY

(Continued from page 16)

switch connecting the corresponding resistor into the circuit and plug in the field desired.

If it is desired to use 2,500-ohm fields instead, the series resistors would have a value of 2,500 ohms each and the fields would be excited by 100 V. at 40 ma. This means, assuming that the same transformer with a current capacity of at least 100 ma. (more for 1,000-ohm fields, to provide a safety factor) is used, that another series group of three may be excited by connecting the second group in parallel with the first.

By disconnecting the fields and resistors and adding a filter, a power supply for experimental equipment is formed. See Fig. 1C for details of these added connections.

## MAKE THIS "SERVICE MAN'S COMPANION"

(Continued from page 45)

- One Sprague tubular condenser, .1-mf., C5;
- One Sprague tubular condenser, .5-mf., C6;
- One Sprague tubular condenser, 2 mf., C7;
- One Sprague tubular condenser, 8 mf., C8;
- One Electrad 50,000 ohms pot., R1;
- One Electrad 10,000 ohms pot., R2;
- One Electrad or Centralab wire wound resistor used as a pot., 50,000 ohms, 25 W., R3;
- One Electrad wire wound resistor vitrous enamel, 10,000 ohms, 25 W., R4;
- One Aerovox carbon resistor, 10,000 ohms, ½-W., R5;
- One Aerovox carbon resistor, 20,000 ohms, ½-W., R6;
- One Aerovox carbon resistor, 30,000 ohms, ½-W., R7;
- One Shalleross or I. R. C. precision resistor, 1,460 ohms, R8;
- One Shalleross or I.R.C. precision resistor, 4,970 ohms, R9;
- One Shalleross or I.R.C. precision resistor, 50,000 ohms, R10;
- One Shalleross or I.R.C. precision resistor, 50,000 ohms, R11;
- One Shalleross or I.R.C. precision resistor, 150,000 ohms, R12;
- One Shalleross or I.R.C. precision resistor, 250,000 ohms, R13;
- One Shalleross or I.R.C. precision resistor, 500,000 ohms, R14;
- One Shalleross or I.R.C. 500 mills. shunt, R15;
- One Shalleross or I.R.C. 100 mills. shunt, R16;
- One Shalleross or I.R.C. 25 mills. shunt, R17;
- One Shalleross or I.R.C. 5 mills. shunt, R18;
- One Shalleross or I.R.C. precision resistor, 100,000 ohms, R19;
- One Shalleross or I.R.C. precision resistor, 50 ohms, R20;
- One Centralab 500,000 ohms pot; R21;
- One Eby S.P.S.T. toggle switch, Sw.1;
- One Eby S.P.D.T. toggle switch, Sw.2;
- One Eby D.P.D.T. toggle switch, Sw.3;
- One Eby 3-P.D.T. switch, Sw.4;
- One Eby S.P.6-T. rotary switch, Sw.5;
- One Eby D.P.6-T. rotary switch, Sw.6;
- One Eby D.P.11-T. rotary switch, Sw.7;
- One Eby S.P.11-T. rotary switch, Sw.8;
- One Eby S.P.11-T. rotary switch, Sw.9;
- Six Eby S.P.S.T. toggle switches, Sw.10, Sw.11, Sw.12, Sw.13, Sw.14, Sw.15;
- One Eby S.P.5-T. rotary switch, Sw.16;
- One Eby S.P.S.T. push button, Sw.17;
- One Eby S.P.S.T. toggle switch, Sw.18;
- One Eby 4-5-6 prong universal socket;
- One Eby 7 universal socket;
- One Eby 4 prong socket, cable plug and adapters;
- One Radio City Products 1 ma. meter;
- One Radio City Products 1 meter rectifier;
- Twenty Eby tip jacks;
- Three Eby insulated phone tips;
- One General Transformer power transformer;
- One Insuline bakelite panel;
- Misc' items, as follows:
- One flush-panel receptacle;
- One 1½ V. cell;
- One ¼-W. neon lamp;
- One neon-lamp magnifier;
- One line cord with two plugs;
- carrying case.

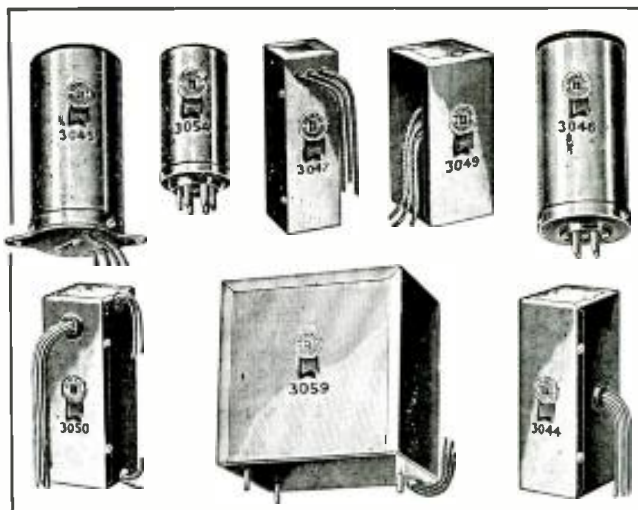

## AUTO RADIO "General" Quality Vibrators for 90% OF SETS IN USE

To insure the most permanent and dependable service General Full-wave Vibrators are provided with the highest grade Swedish spring steel reed and with oversized tungsten contacts—assuring long life.

pendable service General Full-wave Vibrators are provided with the highest grade Swedish spring steel reed and with oversized tungsten contacts—assuring long life.

*Free for the Asking!*

Auto-Radio Vibrator Guide listing 220 models of radios on which you can replace the vibrator with one of 22 General Units.

**General Transformer Corporation**  
504 S. Throop Street, Chicago, Ill.

**—MAIL THIS TODAY—**

GENERAL TRANSFORMER CORPORATION  
504 S. Throop St., Chicago, Ill.

Send me without charge a copy of Vibrator Guide with name of nearest distributor.

Name .....

Address .....

City ..... State.....

## MODEL 110 SIGNAL GENERATOR



## MODEL 500 COMPONENT ANALYSER



MODEL 110

TRIUMPH SCOOPS THE MARKET with a Brand New Kind of Instrument which "analyses" component parts—The Model 500 "CONDENSER-BRIDGE-ANALYSER"—No meters—No delicate adjustments. It tests Coils—Condensers—Resistors right in the set—Radically different in conception and purpose—So simple it will change all present test routine—Eliminates crude "cut and try" and "parts substitution" methods—Cannot be "out dated" by radio developments—Analyses component parts "before replacement"—Checks directly on the source and cause of trouble in circuits—Beautiful Genuine Walnut instrument case, only \$19.95!

WRITE FOR COMPLETE DETAILS TODAY



MODEL 500

MODEL 110 SIGNAL GENERATOR—THE FOUNDATION OF A REAL SERVICE LABORATORY—Directly Calibrated—A.C. Operated—Gene sine T. Pad Attenuator—400 cycle audio output—Modulated or Unmodulated R. F.—Calibrated 100 Kilocycles to 30 Megacycles—i. F. and Broadcast test points in color. Exclusive features—\$29.94.

- A COMPLETE EQUIPMENT LINE**
- MODEL 110—Signal Generator ..... \$29.94
  - MODEL 500—Component Analyser ..... 19.95
  - MODEL 150—Battery Operated Signal Generator—Directly Calibrated—100 K. C. to 30 M. C.—EXTRA LONG LIFE Batteries—Complete ..... 29.94
  - MODEL 300—Multirange Meter—A.C. and D. C. volts to 1000—Resistance ½ ohm to 10 meg—D. C. milliamps to 500 ..... 19.95
  - MODEL 400—Tube Tester—Counter or Portable—Tests Emission—Dynamic Conductance—High Sensitivity Leakage—English Reading—Tests ALL tubes. \*Including NEW METAL TUBES ..... 34.95
- \* PRESENT TRIUMPH MODEL 400 USERS WRITE FOR FREE ADAPTER AND TEST DATA.

**TRIUMPH MFG. CO., 4019 W. LAKE ST., CHICAGO, ILLINOIS**

**GOOD NEWS!!** On the inside back cover of this issue appears an important announcement about the 1935 OFFICIAL AUTO-RADIO SERVICE MANUAL. Be sure to turn to this page now for full particulars.

## TURN SCRAP INTO MONEY



The new and revised edition of "Auto Power" with all the ten original specifications and ten new ones is now off the press. Convert old generators into A. C. and D. C. generators and motors with voltages of 6 to 400 volts, for power, light, welding, and radio operation. Create new generators adaptable for home, automobiles, or trucks. They can be driven by fan belt, wind or water. This book with complete illustrations, tells you how easily and economically these changes can be made. Also instructions for rewinding auto armatures. 350 definitions of electrical terms, etc. Already used and endorsed by thousands. Price \$1.00 postpaid.

**AUTO POWER Dept. C 414 S. Meyne Ave. Chicago**



Please Say That You Saw It in RADIO-CRAFT

# SPECIAL OFFER!

## by the Radio Amplifier Laboratories, Mfrs.



- 1 No. 40 Heavy duty 2-button chromium plated microphone
- 1 EF5S 13 lb. floor stand, chromium plated
- 2 Heavy duty 10" Magnavox Speakers.
- 1 15-watt Power Amplifier with incorporated volume control
- Input impedance for microphone and phonograph
- Output impedance 8, 15 and 500 ohms
- 1 Complete set of matched tubes

**NET COST \$36<sup>90</sup>**

This equipment is manufactured by us. It is *not* surplus merchandise.

ENCLOSE 20% WITH ORDER. BALANCE C.O.D.

Send 5c in stamps for 1935 Amplifier Catalog.

**RADIO AMPLIFIER LABORATORIES** 291 EAST 137th STREET NEW YORK, N. Y.

**WHAT DO YOU KNOW ABOUT THE NEW "HI-FORMATION" ELECTROLYTICS?**

**OUR CATALOG No. 128 WILL TELL YOU ALL ABOUT THEM**

**CORNELL-DUBILIER CORPORATION**  
4347 BRONX BOULEVARD NEW YORK



**UNIVERSAL Combination Floor Stand**

A rugged, three-piece, telescoping, combination banquet and floor stand—Compact—light weight—smooth in operation—Finished in fully polished nickel plate—Equipped with cadmium plated, adjustable and detachable copy holder, mounted on a flexible steel arm—A clean, workmanlike job, designed and manufactured to Universal standards of Quality—List Price, complete with 8 springs, \$10.00.

Universal Microphone Co., Ltd.  
424 Warren Lane  
Inglewood, Calif., U. S. A.

**A.C. CURRENT-ANYWHERE!**  
WITH Kato LIGHT PLANTS



A Little Gas and a Kato AC plant enable you to operate AC radios, amplifiers, refrigerators and all other standard household appliances. Sizes 300 watts and up. Write for interesting descriptive literature.

KATO ENGINEERING CO. Mankato, Minn., U. S. A.  
Mfrs. of AC Generators and Converters for operating AC Radios on 98 and 110 volts DC

**Vacuum Tube Voltmeter AC Operated**

For accurately aligning all wave receivers, and measuring gain in RF, IF and AF circuits, etc. Laboratory accuracy guaranteed, still rugged enough for production or service testing. Range 3 to 1.5 volts, also calibrated in decibels. Frequency range from 15 cycles to 30 megacycles. Price 50% lower than instruments of similar performance. Special introductory price for 60 days \$34.95 prepaid. 10% higher foreign countries. Net weight 1/2 lb.

**ELECTRONIC APPLIANCE CO.**  
1133 Broadway, Room 1027 New York, N. Y.

**A MULTI-TUBE ADAPTER**

(Continued from page 16)

the 4-5 and 6-prong sockets, procure one with a fiber bottom. This fiber bottom can then be taken off and cut off so as to fit into a 7-prong tube base and bolted together.

Figure 1E shows the inner connections of the completed 4-5 and 6-prong tube adapter which is plugged in the 7-prong socket of the large adapter to test the 4-5 and 6-prong tubes.

Figure 1A shows a cross-section of the completed adapter and the piece of heavy white paper which is glued around the edge of the two disks where the jack connections are marked.

Figure 1G shows the make-up of the connectors, the two last ones being made with an extension cord to test the 12.6 V. and the 25 V. tubes.

Tube Type	Heater Volts	Connec-tion No.	Tube Type	Heater Volts	Connec-tion No.
1V	6.3	11	85	6.3	5
19	2	6	2A3	test same as 45	
43	2.5	10	2A7	2.5	12
53	2.5	9	6A7	6.3	12
55	2.5	5	6A4	6.3	14
KR20	2.5	5	KR5	6.3	14
2A6	2.5	5	LA	6.3	14
57	2.5	4	2B7	2.5	13
58	2.5	4	6B7	6.3	13
73	6.3	5	6C6	6.3	4
KR22	6.3	5	6C7	6.3	17
77	6.3	4	6D7	6.3	16
7S	6.3	4	6D6	6.3	4
79	6.3	6	6F7	6.3	16
82	2.5	8	12Z3	12.6	3
83	test same as 80		47	2.5	14
84	6.3	7	PZ	2.5	14
6Z4	6.3	7	25Z5	25	2
P8G1	6.3	7			

Referring to Fig. 2, the following details will explain the various connections of the adapters:  
Connection No. 1. Control grid of tester connects to top of tube.  
Connection No. 2. Put plug in 110 A.C. line.

Various connections for the tube adapters described.

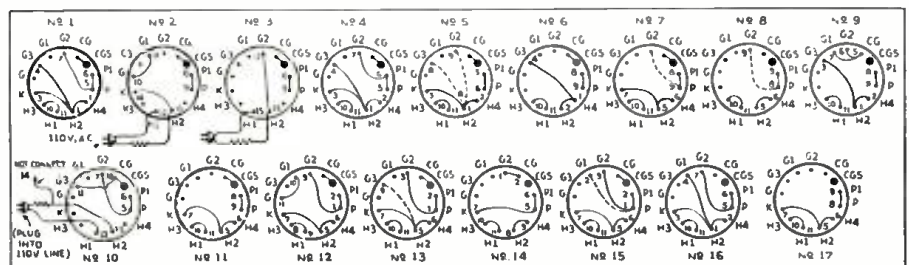

Connection No. 3. Put plug in 110 V. line.  
Connection No. 5. Remove P and P1 when testing diode plates. Control grid of tester to top of tube. Test diode plates as shown in dotted lines. If meter does not move shift No. 8 to 41.

Connection No. 6. C.G. cap of tester connects to C.G.S. on adapter. C.G. jack and G2 connects by 5 and 6. C.G. jack and C.G. of tube connects by 5-7. To test the second plate remove 9 from P1 and connect to K.

Connection No. 7. To test second plate remove No. 8 and connect to G2 as shown in dotted lines.

Connection No. 8. The second plate is tested by switching No. 9 to G2.

Connection No. 9. To test second plate disconnect 8 from P1 and connection to K.

Connection No. 10. Not connected.

Connection No. 11. Control grid cap of test to C.G. stud of adapter.

Connection No. 12. Control grid of tester goes to top of tube in adapter.

Connection No. 13. The control grid of tester goes to top of tube. Diode test; disconnect P and P1 and P and G2. Connect No. 8 and 9 as shown by dotted lines, switch 9 to G1 to test second plate.

Connection No. 14. Control grid of tester goes to top of tube.

Connection No. 15. To test triode plate disconnect No. 2P1 and No. 3G2 and connect No. 2 to G1. Connect C.G. of tester to C.G. of adapter. C.G. jack G3 connects by No. 8-9. Test plate as usual.

Connection No. 16. Control grid of tester connects to control grid cap of tube.

Connection No. 17. Control grid of tester to top of tube. To test diode plates disconnect No. 8 and 9 from P and P6. Connect No. 8 in one side of heater of the tester socket. Connect No. 9 to G1, to test the second plate; shift No. 9 to G3. If meter does not move switch No. 8 to the other side of heater.

**LIST OF PARTS**

- Twelve small jacks;
- One large 7-prong socket;
- One 4-5 and 6-prong socket;
- Twelve phone tips;
- One 4-prong tube base;
- One 7-prong tube base;
- One 3/8-in. thick nut;
- One 1-in. bolt;
- One 3/8-in. bolt with thin head;
- Five ft. of stranded hookup wire;
- One old hard rubber or bakelite panel.

**SERVICE AIDS FOR THE RADIO MAN**

(Continued from page 23)

solved by the handy pocket tool case shown in Fig. 11. It has two partitions that separate various tools.

**Insulating Cambric—5,000 Volt.** A handy item to have in every service shop is "insulating cambric." This is a dry yellow cambric with a breakdown voltage of 10,000 V.

**Dial-Lite Coloring.** The Service Man is often called upon to supply various colored dial lights for all-wave sets, which as a rule he cannot supply. The coloring shown in Fig. 1H should prove to be a good money maker.

**Soldering Iron Rest, Tip Cleaner and Preservative.** An improved tool is the new soldering "kit." The preservative is a flux for the tip, while the cleaner is an abrasive to clean burned tips.

**Liquidope.** Constructing, winding and repairing coils is a job that Service Men are often required to do. In this work liquidope cannot be excelled. The coil dope is shown in Fig. 1E.

Please Say That You Saw It in RADIO-CRAFT



## MODERN SERVICE METHODS AND EQUIPMENT

(Continued from page 21)

The first analyzer had the cord and plug permanently attached through the instrument circuit and to the socket moulded in the panel. The modern analyzer, to take care of the changes that are occurring continuously in radio receivers, has the sockets removed from the panel and incorporated into a separate device.

Advancement has been made in many ways. Features that were not thought of at the time the model 537 analyzer was produced are now made available to help the Service Man in his Shop. A.C. measurements at the present time in the majority of testers are obtained by using rectifier-type meters. The voltage ranges have been designed so that the meter has a high sensitivity, usually 1,000 or 2,000 ohms per volt.

The introduction of tubes with many elements in them has necessitated ways and means of enabling the Service Man to identify the elements and their proper connection into the circuit. Note the numbering system on the selector unit used in conjunction with the model 665 analyzer—a system of numbering which has been developed so that the various elements of a tube and its related circuit are easily identified.

Probably the most important and outstanding feature of the truly modern analyzer is its ability to meet changing conditions without becoming obsolete or without requiring expensive rebuilding. The selective method of analysis whereby an analyzer with a separate socket arrangement is used, was developed especially to avoid that problem.

## A GIANT VOLT-OHMMETER FOR THE TEST BENCH

(Continued from page 21)

1-meg. It is possible to distinguish on the scale the difference between 95,000 ohms and 100,000 ohms. Therefore, any leakage within the tube between the cathode and heater which in shunt with 100,000 ohms will give a net resistance of 95,000 ohms is the maximum leakage resistance the circuit will indicate. In the formula for parallel resistances this value may be determined:

$$95,000 = \frac{100,000 \times R}{100,000 + R}$$

$$95,000 \times 100,000 = 100,000 R - 95,000 R$$

$$9,500,000,000 = 5,000 R$$

$$\text{or } 1,900,000 = R, \text{ the maximum}$$

value of leakage in ohms which can be determined with this circuit.

### LIST OF PARTS

- One 4½ V. "C" battery;
- One 45 V. "B" battery;
- One 5¼ in. triple-scale 1. ma. meter with exactly 50 ohms internal resistance;
- One D.P.-D.T. jack switch;
- One 1,000 ohm wire-wound potentiometer;
- Six pin-jacks (one neg. and five pos.);
- Five carbon (5 per cent), or wire-wound (1 per cent) semi-precision resistors, 4,000, 40,500, 10,000, 90,000 and 400,000 ohms;
- Six carbon resistors (ordinary 10 per cent tolerance for tube short checker) 1-40,000, 1-20,000 and 4-10,000 ohms;
- One 4-prong socket;
- One 5-prong socket;
- One 6-prong socket;
- One 7-prong socket.

The scale for the test bench meter.

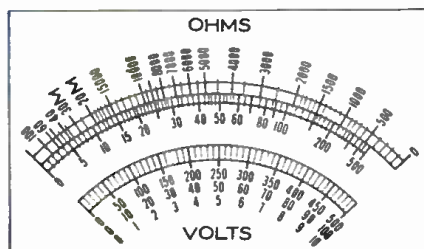

## IMPORTANT FACTS ABOUT GROUP HEARING AIDS

(Continued from page 23)

Freedom from A.C. hum is an important requisite of the deaf-aid amplifier, because hum is very noticeable when earphones are used.

The selection of the location of the outlets determines to a large extent the success of the installation. Do not bunch the phones together so that the users would be made conspicuous by having to sit in a group, but scatter them so that they may sit with their families or friends. Another very essential point to remember is that the outlets be placed so that a strong light will not strike from the wrong direction as many of the users of earphones are also lip readers and it is essential that the speaker's face must be clearly visible.

For a church installation each regular user of the service should be allowed to choose the pew desired, having the extra guest outlets in good locations. (The photo shows such a church installation; outlet connections are shown in the diagram.)

In the theatre, outlets should be located in groups of two, one on the seat frame between the first and second seats, the second outlet between the second and third seats, thus permitting considerable flexibility in seating, since two hard-of-hearing persons may then be seated in any of the first three seats. Several or all of these groups of outlets may then be along one aisle (preferably, in the rear half of the theatre). Outlet boxes should contain, in addition to the phone jack, a volume control unit to meet individual requirements.

Outlet boxes are obtainable which harmonize with different finishes. Generally white or ivory finishes, due to their greater visibility in the semi-darkness, are used in theatres. For churches, a brown crystal finish is usually preferred.

The essential requirements of earphones is that they be light in weight, comfortable to wear, of rugged construction, and capable of handling large volumes of sound without appreciable distortion. Their impedance should match the rest of the equipment.

The lorgnette type phone (a single receiver attached to a handle) is almost always preferred for churches; for the longer theatre program, the single phone with a very lightweight handband is preferred.

The group hearing aid requires a certain amount of attention. In a church, the minister usually arranges (1) that someone turns the current on and off before and after each service; (2) that the users have not left the receivers switched on and thus disturb those in adjacent pews; and (3) that the ushers understand how to replace a disconnected plug or show a stranger how to get the desired volume.

Group deaf-aid installation for the hard-of-hearing is essentially a business for the Service Man. The equipment incorporates apparatus he is thoroughly familiar with. Churches and theatres are at his door and the management are his friends. In every community there are countless numbers of persons who have adjusted themselves to their condition of impaired hearing and are waiting for the help these installations will give.

## ANNOUNCING A TEST UNIT FOR SOUND SYSTEMS

(Continued from page 22)

It is desirous that this sound equipment be kept in good operating shape at all times, in order that the owner may derive the greatest benefit from his investment. In the particular case of the theatre owner, it is imperative that his equipment be operating in order that he stay open. Hence, servicing this type of equipment will be found more remunerative per job than radio set servicing.

The new Supreme model 391 Analyzer has been expressly designed and engineered to provide facilities in one instrument for checking, testing, and servicing every part of any sound equipment.

(A detailed description of the operation and application of this versatile instrument as a sound system analyzer will be continued in Part II in a forth coming issue.)



Today's Most Distinguished Radio Achievement!

## CUSTOM BUILT IMPERIAL 18-TUBE Radio

THIS super radio musical instrument was engineered by master craftsmen for those discriminating and exacting radio enthusiasts, who want a finer, more beautiful, more precisely built radio. The Imperial 18-tube All-Wave receiver, crystallizes all that is fine and new in today's most advanced conception of radio. Scores of new features, many of them exclusive, result in brilliant sparkling performance heretofore unattainable.

This exclusive instrument will bring in more stations, over greater distances with Higher Fidelity than any other receiver. It is fully guaranteed for years of service—for foreign reception—for your satisfaction. The FREE Trial offer enables you to try this super instrument in your own home, for 30 days, without obligation. Write or mail coupon.

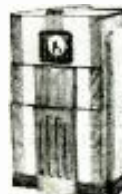

## IMPERIAL

Imperial Radio Crafters  
Division Alford Radio Corp.  
Dept. 255-A, CINCINNATI, OHIO

Without obligation, send me literature describing the Imperial 18-tube radio . . . and details of your 30-day FREE Trial Plan.

Name \_\_\_\_\_  
Street \_\_\_\_\_  
Town \_\_\_\_\_ State \_\_\_\_\_

## STOP GUESSING! WHAT IS WRONG WHAT TO CHARGE

RADIO CHUCKER eliminates guess-work in localizing radio faults, and estimating on the repair price. R. F. Rieck, Chambersberg serviceman, says: "Chucker is quick and accurate; in this customer confidence, insures a good profit." A Philadelphia Serviceman says: "Since using a CHUCKER I have had little difficulty in finding troubles even in complicated radios." Murl F. Beauchamp, Jr., Muskegon, Mich., says: "Using a Chucker helped me to get several tough-to-get repair jobs!" Tremendous acceptance justifies price reduction. Do not send \$1.00. Send just 50c (no stamps) NOW! We'll rush you a Chucker (trouble-graph and repair-price), postpaid!



SEND 50c NOW!

PAUL G. FREED  
(Freed's Radio Co., Publishing Division R1  
5053 Baltimore Ave. Philadelphia, Pa.)

Please Say That You Saw It in RADIO-CRAFT

# COLUMBIA SCORES AGAIN . . . . .

with a totally new kind of combined Portable Public Address System and High Fidelity Recording Outfit which opens new money-making rental and sales opportunities for radio men.

Used by radio stations, motion picture studios, musicians, detective agencies, vocal studios, radio artists, etc. for voice tests, sound effects, advertising records, political speeches, home recording, etc.

Represents the ultimate in instantaneous recording equipment for the highest type of work. Handles 6", 10" or 12" aluminum, celluloid, or other metallic or non-metallic discs. Produces clear, crisp and well defined records with a richness of tone never before achieved in any recorder selling for ten times its price! Send for complete details and NEW FREE Series of Public Address and Recording Bulletins with confidential low net prices. Dealers, Distributors: Write for attractive proposition.

FREE Public Address Consultation Service; Write to Mr. C. R. Shaw for help in selecting the best equipment for your installation.

**COLUMBIA SOUND COMPANY, INC.**

133 Liberty Street,

New York, N. Y.

## Here's the NEW PERMEABILITY-TUNED IRON CORE I. F. TRANSFORMER

The ELWIN LINOPERM uses fixed condensers and adjustable iron core inductances for tuning.



Greater Stability  
Higher Gain  
Greater Selectivity  
Easier and More Accurate Tuning

Moisture proof fixed condenser—moulded in bakelite and vacuum wax impregnated—assures constant amplification unaffected by humidity—negligible capacity drift—nonmicrophonic. All litz windings plus iron cores—High Q—greater selectivity and higher amplification. Long, linear frequency adjustment curve—useful tuning range of iron core evenly distributed over 8-10 turns of adjusting screw—makes accurate tuning easy—even on High Q circuit. Change of frequency with setting so gradual that jars, vibration, and temperature changes have practically no effect on resonant frequency.

Available for all standard intermediate frequencies, in 1 1/2" x 1 1/2" x 3 1/2" or 2" x 2" x 4" cans, in three types, having these characteristics:

- 1—higher gain—normal selectivity
- 2—normal gain—higher selectivity
- 3—diode

In ordering, specify intermediate frequency used, characteristics desired, and size. Prices: All types lots of 50 or over.

Terms: 2% off cash with order. 20% down balance C. O. D. Descriptive literature free on request.

**THE ELECTRICAL WINDING CORPORATION**

22-26 Wooster Street

New York, N. Y.

## REAP THE HARVEST OF YOUR OWN SKILL

Build the **EAGLE E. C. FOUR**



Supersensitive All-Wave. Easy to build and operate. Complete Kit **\$14.95**

Including 8 S.W. Coils. Send for Free Eagle Circuits Also "pay-as-you-build" plan. **EAGLE RADIO, Dept. C, 84 Cortlandt St., New York**

## New CRYSTAL MICROPHONES

Now at Your Jobber (Licensed Under "Brush" Patents)

**SHURE BROTHERS COMPANY**

Microphone Headquarters

215 WEST HURON ST. CHICAGO, U. S. A.

## THE AUDIO-TONE SELECTIVE SIDEBAND SIGNAL GENERATOR



For Modern Radio Servicing  
Single sideband modulation. R.F. output with modulation continuously variable to 10,000 cycles. A.F. output 60 to 10,000 cycles. For amplifier servicing and overall receiver testing.  
Licensed under A. T. & T. Co. Patents.  
Model 30-B A.C.-D.C. Operated—\$48.00 net.  
**THE AUDIO-TONE OSCILLATOR COMPANY**  
Springfield, Massachusetts

## BASIC SERVICE FUNCTIONS OF THE SIGNAL GENERATOR AND MULTI-METER

(Continued from page 22)

Operating a signal generator is quite a simple matter. Only two adjustments need be made—first, the frequency, next the output in microvolts. The adjustment of these controls can be grasped immediately by any technician. The band switch and the tuning dial control frequency, and the multiplier and attenuator control output voltage.

The output plug shown at A has one position at which full output is obtained at one-half volt. In the opposite position it reduces output to one-tenth of that value, or 50,000 microvolts, so it may be said to supplement the output controls. The 50,000 microvolt output is reduced to zero by adjustment of the multiplier and attenuator. These microvolt values are read on a multi-meter, a suitable type of which is shown at B.

The input (from generator to set) is read at the attenuator controls in approximate microvolts. While generator output is not given in microvolts absolute, a very dependable indication of relative sensitivity can be had from the better service signal generators having stable frequency characteristics and a properly proportioned attenuator system. The output of the set can be read at the plate of the output tube or across the speaker voice coil with a high impedance A.C. voltmeter.

Tables are given herewith to permit converting A.C. volts read across the voice coil to milliwatts output for a signal modulated at 400 cycles.

It is probable that cathode-ray tube equipment will eventually be used by Service Men for visual alignment and testing of radio receivers. However, such equipment, when it does become popular, will merely supplement, not supplant, the signal generator and multi-range-meter.

TABLE I—Voltage Indication on High-Impedance A.C. Voltmeter for Output Watts

*Voice-Coil Impedance	200		1/2		1	
	Milliwatts	Watt	Watt	Watt	Watt	Watt
2	.633 V.	1. V.	1.41 V.	1.73 V.	2. V.	2.44 V.
3	.775 V.	1.25 V.	1.73 V.	2. V.	2.44 V.	2.82 V.
4	.895 V.	1.41 V.	2. V.	2.44 V.	2.82 V.	3.16 V.
5	1. V.	1.58 V.	2.24 V.	2.82 V.	3.46 V.	3.74 V.
6	1.1 V.	1.76 V.	2.44 V.	3.16 V.	3.74 V.	4. V.
8	1.262 V.	2. V.	2.82 V.	3.46 V.	4. V.	4. V.
10	1.41 V.	2.24 V.	3.16 V.	3.74 V.	4. V.	4. V.
12	1.55 V.	2.44 V.	3.46 V.	4. V.	4. V.	4. V.
14	1.67 V.	2.64 V.	3.74 V.	4. V.	4. V.	4. V.
16	1.78 V.	2.82 V.	4. V.	4. V.	4. V.	4. V.

*Voice-Coil Impedance	3		5		20	
	Watts	Watts	Watts	Watts	Watts	Watts
2	2.44 V.	3.16 V.	6.33 V.	7.75 V.	8.95 V.	10. V.
3	3. V.	3.27 V.	7.75 V.	8.95 V.	10. V.	10.1 V.
4	3.46 V.	4.46 V.	8.95 V.	10. V.	10.1 V.	12.62 V.
5	3.86 V.	5. V.	10. V.	10.1 V.	10.1 V.	14.1 V.
6	4.25 V.	5.46 V.	10.1 V.	10.1 V.	10.1 V.	15.5 V.
8	4.9 V.	6.31 V.	12.62 V.	15.5 V.	16.7 V.	17.8 V.
10	5.48 V.	7.06 V.	14.1 V.	16.7 V.	17.8 V.	17.8 V.
12	6. V.	7.74 V.	15.5 V.	17.8 V.	17.8 V.	17.8 V.
14	6.47 V.	8.35 V.	16.7 V.	17.8 V.	17.8 V.	17.8 V.
16	6.92 V.	8.95 V.	17.8 V.	17.8 V.	17.8 V.	17.8 V.

\*To find voice-coil impedance (at 400 cycles) read D.C. resistance and add 20 per cent; i.e., voice coil D.C. resistance—5 ohms, the impedance is 6 ohms.

## DEAF-AID EQUIPMENT A SERVICE MARKET

(Continued from page 24)

ance to the installation. The easily mounted control boxes contain a 10,000-ohm potentiometer-type volume control, and jack to take the phone plug. Connections are in parallel to prevent variations in volume or a click in the phones when additional hand sets are plugged in or removed.

Although the standard finish for devices of this type is black crystalline, aluminum finish is a suggestion for theatre use so that the control boxes may be more readily seen.

The head sets are supplied complete with plug. The phones are of the single head-set and single narrow band type, light in weight, that fit the ear and are not conspicuous.

Let's consider an installation of this equipment in a theatre. There are several ways of utilizing the sound from the pictures. Most projection booths have a monitor speaker that derives power from its own amplifier, or from a line tapped to the main amplifier. The low-impedance input of the amplifier can be attached to the monitor speaker circuit. A second suggestion that has sometimes been made is to place the microphone on the stage to pick up the output of the theatre speaker system. This involves double amplification and includes amplifying speaker distortion and we would not recommend it. A third, and probably best, suggestion is to connect the 10,000 ohm high-impedance input of the amplifier across the low-impedance stage speaker line. Plenty of gain in the amplifier will overcome the loss in this mismatch, and tone quality in the phones will not suffer; and due to the high impedance of this input, neither tone quality nor volume of the theatre speaker system will be affected.

In locating control boxes the writer would recommend not over two or three to a row as this allows friends of the "deaf" person who do not need the "aid" to sit with them. Most of the boxes should be placed near the rear center. Out-of-the-way corner seats are not going to attract this type of customer but, except for a few locations, they can be toward the rear of the house as the view of the picture is as good or better here than nearer the front. A few control boxes could be placed toward the front for those whose eyesight as well as hearing is defective.

(The writer will be glad to advise on installation procedure in the event that any RADIO-CRAFT readers experience difficulty in determining the number of phone units that may be operated from one amplifier, etc.)

## NEW MONEY-MAKING POSSIBILITIES IN A PORTABLE P.A. DEMONSTRATOR

(Continued from page 24)

preserving memorable events and sound impressions, it stands to reason that home recording will no doubt take on, in time, the magnitude assumed by the camera in filling the family album with collections of rare individual and group photographs, as well as pictures of special events and occasions. Consider for a moment all of the sales advantages offered to the Service Man who decides to sell or rent this type of equipment while conducting his regular service duties.

In the first place, he is in a position to buy high-grade portable recording equipment which performs on a par with most expensive outfits. Secondly, he has an excellent opportunity of demonstrating the system under the pretext of checking the fidelity of the A.F. system of a radio receiver. In making this test he plays a standard commercial phonograph record through the radio set and inadvertently shows his customer how easy it is to use his radio set as an electric phonograph for the reproduction of phono records.

Many Service Men have found that customers who would ordinarily balk at the idea of a "cold" canvasser making any kind of demonstration on their radio set, have eagerly watched the Service Man test the A.F. amplifier and speaker and, once having listened to the electrical reproduction of phonograph records through their radio set, proceed to practically sell the equipment to themselves.

(Part II in a forth-coming issue will conclude this interesting article.)

(Continued on page 63)

Please Say That You Saw It in RADIO-CRAFT



## PHILCO VS. G.E. METAL TUBES

The article below is the contents of a full page advertisement which appeared in the New York Times April 8th. Additional information may be found on page 6.

### AN ANNOUNCEMENT OF VITAL INTEREST TO EVERY RADIO OWNER . . . AND TO THE RADIO TRADE

"In view of recent experimenting with radio tubes, the Philco Radio & Television Corporation believes it is fulfilling its obligation to the public by presenting the facts on this subject, as it knows them, to the American people. These data, presented to radio owners and to the radio industry, are the conclusions drawn from years of research, study, and experience in building 5,500,000 radio instruments. These conclusions, in addition, are based on the experience of the British affiliate of this company, the Philco Radio & Television Corporation of Great Britain, Ltd. They summarize, therefore, the findings of the research and engineering departments of the Philco Radio & Television Corporation both in America and England.

"These findings establish the fact that the glass radio tube is of the highest radio performance value today. This corporation has had first-hand contact with metal radio tubes in England. Metal radio tubes in England were a dismal failure. They are now defunct. "While a metal radio tube might develop possibilities in the future, it is today still in an experimental stage. While the metal radio tube might be of some interest to the public because of the novelty of the idea, its disadvantages are far greater than its present advantages.

"The Philco Radio & Television Corporation considers it only the part of wisdom for the American radio industry to proceed cautiously with the introduction of metal radio tubes in this country. The American radio industry should not, in justice to the public, and to itself, rush pell mell into metal radio tubes. The English catastrophe must not be repeated here.

"The Philco Radio & Television Corporation engineers and research scientists point out that the American public has available more than forty types of high efficiency glass tubes. These have been brought to their present high state of perfection over many years of scientific research and development. These tubes are giving the public double the performance of a few years ago.

"Progress continues on glass tubes; experimentation on metal tubes should be encouraged. Metal may possibly some day take its place alongside glass for radio tubes. In Philco's opinion that day has not arrived as yet. Certainly the American radio industry must not experiment on the public.

"Metal, to date, in the opinion of the Philco Radio & Television Corporation offers no worth while improvement over glass in radio performance, but does introduce great disadvantages.

Here are some disadvantages of metal radio tubes—  
 "1. With the proposed American metal tube construction, bulb size is increased. With an equal amount of heat to dissipate, the smaller metal tubes must operate at a higher surface temperature than the larger glass tubes.

"High temperature is not only detrimental to tube life, but changes the characteristics of nearby coils, resistors, etc., thus upsetting the delicate balance of all the various parts of a radio, which is absolutely necessary for fine performance.

"This could be avoided by spacing the coils farther away from the metal tubes, but this requires more space, not less.

"2. Production difficulties in the proposed metal tubes restrict the manufacture of certain highly desirable multiple function types which are in general use in glass. The proposed metal tubes are limited to a few types—principally single function types.

"3. Thus, to achieve a given performance, more metal tubes than glass tubes are required. This again requires more, not less, space in a radio.

"4. Also, the additional metal tubes add to cost and electric current consumption without adding to performance.

"5. The transparency of the glass tube often allows the user, or Service Man, to determine when a tube is not functioning. It is a great help in factory inspection. The inability to see inside a metal tube is a real disadvantage.

"6. Loss of vacuum is a serious hazard in the proposed American metal tubes, because, as compared to glass tubes they require twice as many vacuum seals and each seal is much more intricate. Any air leak at any one of the sealing points in any metal tube stops the radio from working. Advantages of glass radio tubes over metal radio tubes today are—

"1. Present-day highly perfected, high efficiency glass tubes are available in every conceivable single and multiple function type, which allows present-day radio sets to give better performance than was available a few years ago with twice as many tubes.

"2. In the wide choice of types of glass tubes, a higher power output of pure tone is available as compared to the proposed metal tubes.

"3. Glass tubes are practically fool proof. With all their highly scientific design, breakage in the factory and in service is practically nil. Their ruggedness is attested by the fact that they are universally shipped installed in their sockets ready for use, and that they

# A UNIVERSAL TEST BENCH SPEAKER



Laboratory Model Illustrated

- Test sets without their Speakers!
- Saves time, worry, work and money!
- Repair any radio without its Dynamic!
- Matches any tube or output circuit!
- Supplied by leading radio jobbers!
- Portable Model (Net Prices) . . . . \$13.50
- Laboratory Model . . . . . \$12.90
- Panel only, completely wired . . . . \$11.75

## The Dynatest . . . . .

Use the Dynatest Speaker for any radio chassis which you desire to repair without its regular speaker! A multiple field tapped at 650, 1000, 1500, 2000, 2500, 3000, 5000 and 11,000 ohms with special taps at 300 and 2500 ohms.

Matches any power tube circuit with two special universal transformers. Matches any output transformers. New style binding posts facilitate easy circuit selection. Size of panel. 12"x12"x4 1/2" deep.

WRITE FOR YOUR FREE DYNATEST SERVICE INSTRUCTIONS—AND YOUR COMPLETE OXFORD REPLACEMENT SPEAKER CATALOG

# OXFORD RADIO CORP.

350 W. Huron Street

Chicago, Illinois

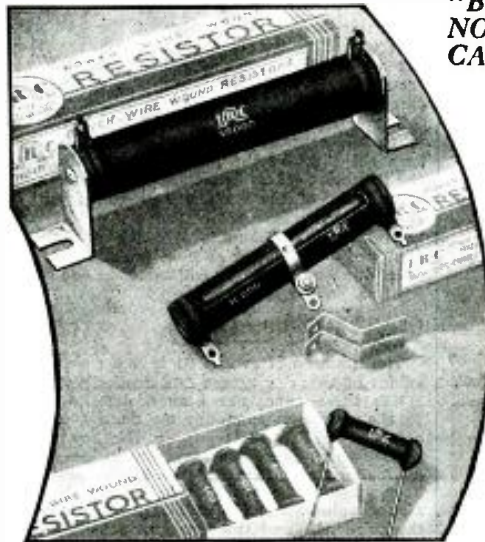

"Be not the first to try the new—NOR YET THE LAST TO DISCARD THE OLD!" . . .

Throughout the world, wide-awake servicemen and hams are turning to IRC CEMENT COATED Power Wire Wound Resistors because impartial tests have shown—

- Lower surface temperature—longer life.
- Greater load capacity and greater mechanical strength.
- Non-porous ceramic core avoids absorption of moisture.
- Moisture and humidity proof.

FOR SERVICEMEN Type PB 10-Watt List 35c	FOR HAMS Type PGA, 100-Watt 50,000 ohms List \$2.00
--	--

All popular values and ratings carried by leading jobbers. Write for Catalog R-24.

INTERNATIONAL RESISTANCE CO.,  
 2100 Arch St., Philadelphia, Pa.  
 187 Duchess St., Toronto, Ont., Canada  
 (Prices slightly higher in Canada)



## POWER WIRE WOUND RESISTORS CEMENT COATED

### HAVE YOU A RADIO-CRAFT INDEX?

By subjects, issues and authors, the July 1929 to June 1932 issues of RADIO-CRAFT are indexed and cross-indexed, in a publication you may obtain for only 25c. You may send stamps or coin for this amount to the publishers of this magazine for your copy. Its use will save you time and money!

withstand transportation by rail, truck, steamship, and loading and unloading, without injury or breakage. Also, millions of radios using glass tubes are in daily use in automobiles and trucks driven over all kinds of roads.

"4. Loss of vacuum is practically unknown in glass tubes.

"5. In short-wave reception, all experience points to glass as better. The prime requisites in handling short-waves are good dielectric properties and good insulation. Glass is inherently a good dielectric and a good insulator.

"These facts are presented to radio owners and to the radio trade so that they may judge and act on the facts and the facts alone."

SEND FOR THIS

# FREE CATALOG

**Bargain Bulletin**

**RADIO-CRAFT**

**NEW ISSUE JUST OUT**

Check full of BARGAINS in RADIO SETS, Long and Short Wave Apparatus, Servicemen's Repair and Replacement Parts, Electrical Appliances and hundreds of miscellaneous specials at **TREMENDOUS SAVINGS.**

Get this big new Bargain Book. It's absolutely FREE without obligation—just send us your Name and Address on a post card

**WRITE FOR YOUR COPY NOW.**

**JUST OFF THE PRESS**

RADIO CIRCULAR CO., INC.  
 225 RC VARICK ST., NEW YORK

Please Say That You Saw It in RADIO-CRAFT

# Alloy

## HIGH PERMEABILITY CASTINGS ELIMINATE ALL HUM 75c

Measures 2 1/2" x 2 1/2" x 2 3/4" Available in all sizes.

### High & Low Tone Equalizer

Greatly improves tonal reproduction of your Radio or P.A. Amplifier. No soldering or changes required. Housed in above case ..... **\$2.45**

Write for prices on Alloy High Permeability. Low Cost. High Grade Transformers—24 Hour Service—Audio. Power, Transmitting Transformers. Built TO ORDER.

**ALLOY TRANSFORMER CO.**  
135R Liberty St. New York City.

# It's NOW

EVERYDAY SCIENCE AND MECHANICS is the best scientific—technical—mechanical constructional magazine in the field. Up-to-the-minute with news flashes of scientific events. Dozens of constructional articles and many popular experiments. Ideas from which you can make things to sell.

**A MOST OF INTERESTING SUBJECTS COVERED:**

- Woodworking — Photography —
- Magic — Patents and Inventions —
- Book Review — Metal-working —
- Chemistry — Engineering —
- Microscopy — Electrical Experiments —
- Household Hints —
- Astronomy — Prize Contests —
- and other subjects.

# 10¢

**Get your copy today! On all newsstands**

**10c the copy**

Over 150 Illustrations

**We SPECIALIZE in the Design and Manufacture of Public Address Amplifiers SEND FOR FREE CATALOG! Number K-30**

Describes in detail 86 different models and complete P.A. Systems ranging up to 200 audio watts output. 6 volt; AC; DC.

**Buy Direct from Manufacturer AND SAVE BIG MONEY**

**Coast to Coast Radio Corp.**  
559-B Sixth Ave. New York, N. Y.

### FLARED BAFFLE HORNS FOR CONE SPEAKERS

Improve the frequency response, increase efficiency, and control sound distribution of your cone speaker. This flare baffle in place of a flat one will result in improved performance. Size 3 1/2" x 1 1/2" x 1 1/2". Weatherproof—brush aluminum—available for any size cone. Net price \$3.95.

Write for our complete Catalog.

**MACY ENGINEERING COMPANY**  
1454 39th St. BROOKLYN, N. Y.

**WHEN BETTER AERIALS ARE MADE LYNCH WILL MAKE THEM... AND OTHERS WILL TRY TO COPY THEM**

Write for Free Bulletin on LYNCH PATENTED and GUARANTEED Noise-Reducing Antennas for Home, Auto Use.

**ARTHUR H. LYNCH, INC., 227 Fulton St., N. Y.**  
PIONEER OF NOISE-REDUCING AERIALS

## CONSTRUCTION AND USE OF A BRIDGE-TYPE CONDENSER TESTER

(Continued from page 25)

it is necessary to apply both D.C. and A.C. voltages to the condenser under test. To prevent D.C. from flowing through the headphones of the regular bridge circuit, a blocking condenser, C1 is placed in series. This condenser has no effect on the A.C. flowing in the circuit during tests.

The 110 V. A.C. line voltage is applied to the secondary side of a standard A.F. transformer having a ratio of about 4 to 1. The reduced voltage from the primary winding is applied to the two end terminals of a 20,000 ohm potentiometer. The voltage drops between the variable contact arm of the potentiometer and each end terminal is then applied to a known capacity (by means of a switch) and an unknown capacity respectively.

It is very important to use the exact type potentiometer specified in the parts list. If any other type is used, the specially prepared scale will not be accurate and the entire circuit will be useless.

The milliammeter and 400 V. D.C. source are not to be connected permanently in the circuit, as tip jacks 9, 10, 11 and 12 allow their connection when it is necessary to use them. These are only required in testing electrolytic condensers as explained later.

We recommend mounting the scale of Fig. 2, in the following manner: Punch out the center 3/4-in hole so that it will fit over the shaft of the potentiometer. Obtain a sheet of isinglass or celluloid from a dealer handling automobile-top repair parts. This should be the same size or slightly larger than the scale shown in Fig. 2. Cut a hole in the center of the celluloid so that it will fit over the shaft and place it over the paper scale. This will protect the scale from injury, while handling. The scale is read through the celluloid.

There is one definite way in which the knob is to be mounted. This is important. First, turn the shaft of the potentiometer all the way to the left; that is, counter-clockwise. Set the pointer of the knob exactly on "short" and tighten the set-screw so the knob will rotate the shaft. This done, rotate the knob all the way to the right, which should make the notch or pointer of the knob fall opposite the "open" position on the scale.

### USING THE BRIDGE

The function of switch S1 is to connect known values of capacity across one arm of the bridge. While these capacities bear a definite relation to the unknown capacity, we do not use their actual values in determining the condition of an unknown unit. It is much easier and less confusing to use a simple multiplier scale. We have arranged this circuit to employ four multiplier values. The first is .1, the second .01, the third .001 and the fourth .0001. Note these are not capacity values. They are multiplier values only. S1 is used to select the multiplier value. Therefore, it would be a good plan to mark the panel under the knob of S1 so that you will always know the value of the multiplier you are using.

To use this instrument, connect tip jacks 1 and 2 to the 110 V. A.C. line. Connect the headphones to tip jacks 7 and 8. Connect the test leads to tip jacks 3 and 4. Next connect a .5 mf. condenser to the test leads. This will allow you to test the operation of the circuit.

Set S1 to the .1 multiplier position. This will connect 5mf. of "known" capacity into the circuit. This multiplies the scale by .1 (one-tenth). Rotate the knob until you have no signal in the phones. The pointer on the knob should be at approximately 5 on the scale, providing the actual capacity under test is .5-mf. (we get the actual capacity value by multiplying the 5 of the scale by .1).

To further check the .5-mf. unit under test, set switch S1 to the .01 multiplier position. This will connect .5-mf. (C7) of "known" capacity into the circuit which multiplies the scale by .01 (one-hundredth). Rotate the knob again until you have no signal in the phones. The pointer should now be at approximately 50 on the scale, again proving that the actual capacity is .5-mf. because this time we multiply the 50 by .01.

Likewise, we can again check the .5-mf. condenser by turning S1 to the .0001 multiplier

position. This time we should get the no signal point at approximately 500. As we multiply this by .001, we move the decimal point over three places to the left, giving .5 again for the capacity.

The no signal point can be obtained at a point to the left of 500 when S1 is turned to the .0001 multiplier position. However, as this is off the calibrated position of the scale, this "no sound" point should be disregarded.

In checking the capacity of one "known" capacity by four positions of S1 you will probably note that all readings will not agree exactly. This is to be expected because of the reason that commercial condensers are manufactured with a plus and minus tolerance of 10 per cent from the specified value. It is a difficult matter to make two things exactly equal in value and this most certainly applies to capacity, resistance and inductance.

The highest degree of accuracy is obtained when the "no sound" position occurs near point 50 on the dial. Therefore, it is advisable to use the multiplier position of S1 that most nearly makes the "no sound" point occur near 50.

Tests For Opens and Shorts. Shorts and opens will be indicated on this tester. To prove this, short-circuit terminals 3 and 4. No sound now will be heard when the knob is turned all the way to the left. To prove an open circuit, remove both (or one) leads from the terminals 3 and 4. Note that the no sound point will now occur with the knob turned all the way to the right. Both operations just described, in effect, represent conditions of shorts and opens.

Leaky condensers can be detected by noting that a complete dying out of the signal in the phone will not take place although there will be a minimum sound point on the dial.

Electrolytic Tests. Electrolytic condensers are easily tested with this circuit. As before, the condenser to be tested is connected between terminals 3 and 4. Make certain that terminal 3 is connected to the negative lead of the condenser. A high D.C. voltage source (if no high D.C. voltage from an A.C. power unit is available, two or more 45 V. batteries may be used) is connected between terminals 11 and 12, observing the polarity shown in Fig. 7. A high range milliammeter (0-100 ma.) is now connected between 9 and 10. As a precaution, the 1 ohm rheostat should be turned all the way to the right so as to short circuit the meter. This is done to protect the meter in case of a complete short in the electrolytic condenser. The initial current is quite high and when operating current is developed, the rheostat should be gradually turned to the left until it is in the "off" position. (The rheostat should be the open end type.) If there is a complete short, then the condenser should be discarded then and there.

A complete short will be evident after the condenser has been in the circuit for a few minutes since the current will not reduce to less than 10 ma.

Resistance Tests. Resistance can be checked with this circuit in the same way that condensers are tested. Referring to Fig. 1, first turn S1 to the off position. Connect the resistance to be tested to terminals 3 and 4. Another resistance of known value is connected to 5 and 6. The knob of the potentiometer is now rotated for the "minimum" or "no sound" point in the phones. Suppose the "no sound" point occurs at 1/4 (one-fourth) on the scale. Then the resistance across 3 and 4 is equal to

Fig. 2  
The calibrated scale for the bridge unit.

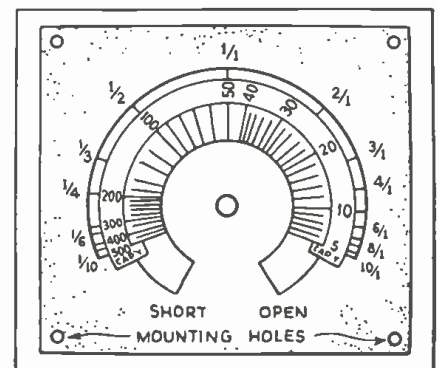

Please Say That You Saw It in RADIO-CRAFT



one-fourth of the known resistance across 5 and 6. Incidentally, if the resistance across 5 and 6 is somewhat near the value of the one across 3 and 4, then the "no sound" point will be found near 50 on the scale. We suggest that you try this method on several resistances. You will certainly be surprised at the ease of operation.

Another point to bear in mind when testing resistances is that the "no sound" point may occur to the right of 50 on the scale. In this case, the resistance across 3 and 4 is greater than that across 5 and 6. For instance, suppose the knob points to 3/1, then the resistance across 3 and 4 is 3 times that across 5 and 6.

**Transformer Ratio Tests.** If you want to know the ratio of any transformer, connect one winding to 3 and 4 and the other to 5 and 6. If you fail to get a "no sound" point, then reverse the connection of 5 and 6. Then a minimum sound point will be obtained. If the "no sound" point is to the left of 50 on the scale, then read the ratio directly as 1/3, 1/4, etc. Should the pointer be to the right of 50, as on 4/1, then the winding across 5 and 6 has four times the turns of that across 3 and 4. This method can be applied to any type of transformer having several secondary windings. This test will also tell if the winding of a transformer is shorted or open, since the dial will read short or open, should either condition be present.

**LIST OF PARTS**

- Twelve tip jacks;
- One non-shorting 1-gang 5-point switch\*, S1;
- One special 20,000 ohm potentiometer\*;
- Six 1 mf. paper condensers, C1, C2, C3, C4, C5, and C6;
- One 5-mf. paper condenser, C8;
- One .05-mf. paper condenser, C8;
- One .005-mf. mica condenser, C9;
- One 1 ohm rheostat, R1;
- One A.F. transformer ratio 4 to 1, T1;
- One 30 henry choke, T2;
- One set of headphones with band;
- One set test leads with clips.

\*The name of manufacturer and type number will be supplied upon request.

**DON'T FAIL TO VOTE FOR YOUR FAVORITE SUBJECTS**

The editors desire to make RADIO-CRAFT just the kind of a radio magazine you think it should be, and you can help them tremendously if you will be good enough to cut out the following ballot, or else make a copy of it (a post-card will do), and send it to the Editor of RADIO-CRAFT, 99 Hudson Street, New York City.

SUBJECT	More	Less
Short Waves		
Radio Beginner's Items		
Electronics		
Public Address		
Auto Radio		
Service Equipment and Procedure		
"Treasure" Locating		
Radio Set Construction		
Test Equipment Construction		
Battery Receivers up to 3 Tubes		
Ditto, 4 Tubes and Over		
A.C. Receivers, up to 3 Tubes		
Ditto, 4 Tubes and Over		
Commercial Receivers (Kits)		
Radio Month in Review		
Radio Pictorial		
Latest in Radio		
International Radio Review		
The All-Wave DX Listening Post		
Short-Cuts in Radio		
Readers' Department		
ORSMAs Members' Forum		
Operating Notes		
Information Bureau		
Radio Service Data Sheets		
Radio Broadcast Station Listings		
I wish to see articles on the following:		
.....		
.....		
.....		
Name .....		
Address .....		
(Clearly print name and address.)		

**HOW TO USE THE SELECTIVE SIDEBAND SIGNAL GENERATOR IN RADIO SERVICE WORK**

(Continued from page 25)

adjustments are impossible.

The newer application of cathode-ray tubes for receiver analysis work has presented methods of visualizing the character of alignment necessary for the reception of all the modulated sideband frequencies, yet one can but feel that the everyday application of these devices must be confined to the production shops. The Service Man's needs are more along the lines of inexpensive signal generators which can reproduce all of the functions of a broadcast transmitter, in factors convenient for measurement. A signal generator which requires no additional accessories and which employs the standard output meter as well as the operator's ears for the determination of proper reproduction is the practical solution.

The selective sideband type of signal generators which have recently been developed, offer an inexpensive source of modulated R.F. which can be employed for the exact analysis of overall receiver selectivity, I.F. balance for distortion detection as well as A.F. and speaker response. As this type of Service Man's signal generator is of the single sideband type, it can produce a complete series of modulated sideband frequencies,—allowing this analysis of the receiver response to both upper and lower sideband components, identical with those transmitted by the high-fidelity broadcast transmitters. The modulation frequency for the signal generator is controllable from the lowest which the speaker will reproduce to approximately 10,000 cycles, permitting service alignments and quick measurements of all audio frequencies.

The selective sideband type of signal generator for these tests is usually operated at a fixed R.F., rather than being variable, because of the oscillator balance necessary to produce the single sideband type of modulation. For routine service work these generators can be employed in conjunction with the conventional type of all-wave signal generator, permitting the exact R.F. analysis as well as the I.F. and A.F. alignment check measurements after the usual service tests have been made. One model of the selective sideband type of signal generator operates in the broadcast band, producing single sideband modulated components from 10,000 cycles for the lower sideband continuously variable to 10,000 cycles for the upper sideband. This range has proven to be more than sufficient for all types of receiver analysis.

This type of signal generator can produce the equivalent of a high-fidelity radio transmitter for all production and service tests and can be modulated at any frequency needed for alignment, response or speaker testing. The single sideband type of modulation employed in this type of signal generator permits an exact analysis of receiver response as well as providing a measure of the balance in reproduction of both groups of sideband modulation frequencies which are transmitted by all broadcast transmitters. If the response to any sideband frequency is not exactly balanced on each side of the transmitter carrier serious detector distortion will result, giving a guttural type of reproduction, so annoying to the listener.

This type of signal generator also offers a source of A.F. for the determination of audio amplifier response and permits the testing of tone control, or the measurement of equalizing networks.

Selective sideband type signal generators have also been built employing the single sideband type of modulation for the broadcast band with standard test modulation for the other frequencies for the all-wave signal generator. This type of signal generator (see Fig. A), with a frequency range from 100 kc. to 22,000 kc., and with the A.F. modulator output, becomes the most practical tool for the radio Service Man and the inexpensive weapon of offense in the shadow of the on-rushing war clouds of high-fidelity servicing.

*Interested in*  
**SHORT WAVE?**  
*Then you need this*

**FREE SHORT WAVE MANUAL**

Here between the covers of this 32 page book you will find the complete descriptions of all that is best in short wave receiver design. Thirteen sets are fully described and illustrated—every one a top notcher—the "cream" of the 1935 crop!

Over 70 illustrations and diagrams make it an outstanding book which anyone needs who wishes to construct a simple yet efficient set for s.w. reception!

Here at **SHORT WAVE HEADQUARTERS**, where we collaborate with every leading manufacturer, we can supply you with any standard parts for any kit described in the **Hammarlund Short Wave Manual**, Popular Mechanics, Radio Craft, Short Wave Craft, Radio News and many others.

Consult us before you build! **SAVE MONEY** by buying from us at lowest **W/WHOLESALE** prices!



**Build This Lafayette UNIVERSAL BRIDGE**

Here is a low priced Bridge which will measure resistances from .01 ohm to 1 megohm and capacities from 100 mfd to .0001 mfd.—with an overall accuracy within 5%. Many uses will suggest themselves, for instance: for measuring the accuracy of condensers; checking resistances of contact switches, etc.

Complete kit of Parts with full directions for assembly and use \$10.95  
If wanted wired and assembled, add..... 1.00

**WHOLESALE RADIO SERVICE CO.**  
100 SIXTH AVENUE - NEW YORK, N. Y.

**WHOLESALE RADIO SERVICE CO.**  
100 Sixth Ave., New York, N. Y., Dept. C-75  
 Send me your FREE S.W. Kit Manual for 1935.  
 Send me the order in attached letter.

Name.....  
Address.....  
City.....State.....



**THOR**  
A. C.  
**Amplifier**  
Model 3F  
4 WATTS

1-57 1-2A5 1-60

No single feature has been overlooked in making this an outstanding amplifier. The circuit is one of simplicity—yet employing the latest in tube circuit design.

This 3-tube A.C. Amplifier Kit with complete parts for construction, including wiring diagram and instructions... **\$5.95**

DYNAMIC SPEAKER \$2.50 EXTRA—  
SET OF MATCHED TUBES \$1.52 EXTRA  
Black Crackle Chassis and Transformer Cover,  
Kits Shipped Ready Mounted.

Send for Free Circuit Data

**MAIL ORDERS FILLED**

**THOR RADIO**  
CORP.  
167 GREENWICH ST. - NEW YORK CITY

Please Say That You Saw It in RADIO-CRAFT

# Most Amazing TYPEWRITER BARGAIN

**TODAY  
FREE TRIAL  
OFFER** **EVER  
OFFERED**



**NEW  
REMINGTON  
PORTABLE only 10¢  
A DAY**

**FIRST TIME!** Remington's new purchase plan now lets you buy a genuine latest model Remington Portable No. 5 direct from the factory for only 10¢ a day. Not used or rebuilt. Not incomplete. A beautiful brand new regulation Remington Portable. Standard 4-row keyboard, standard width carriage, margin release on keyboard, back spacer, automatic ribbon reverse, every essential feature found in standard typewriters.

With your machine we send you free a 19-page course in typewriting. Teaches touch system quickly, easily. Soon you dash off letters quicker than with pen and ink. You also get a handsome, sturdy carrying case free.

**FREE  
Typewriting  
Course**

**BIG PRICE REDUCTION**

The amazing low price and easy terms now make it possible for you to buy this genuine complete Remington Portable for only 10¢ a day. But we cannot guarantee present prices long. Higher wage scales, rising cost of materials, everything points to higher prices. So we say, "Act now... while our liberal offer still holds good!"

**FREE  
Carrying  
Case**

**You Don't Risk One Cent**

Try this typewriter in your home or office on our 10-day FREE TRIAL OFFER. Then, if you do not agree that it is the finest portable of any price, return it at our expense. You don't even risk shipping charges. Don't wait. Mail coupon now. It's the best chance you've ever had to own so complete a machine for so little money. So act NOW!

**CLIP COUPON NOW**

Remington Rand, Inc., Dept. 189-7  
205 East 42nd St., New York City

Please tell me how I can buy a new Remington Portable typewriter for only 10¢ a day. Also enclose your new catalog.

Name \_\_\_\_\_  
Address \_\_\_\_\_  
City \_\_\_\_\_ State \_\_\_\_\_

**CLASSIFIED ADVERTISEMENTS**

Advertisements in this section are inserted at the cost of twelve cents per word for each insertion—name, initials and address each count as one word. Cash should accompany all classified advertisements unless placed by a recognized advertising agency. No less than ten words are accepted. Advertising for the August, 1935, issue should be received not later than June 5.

**A.C. AUTO GENERATORS**

TWENTY NEW PRACTICAL CHANGES FOR automobile generators. See our advertisement at bottom of page 47. Auto Power Inc.

**ELECTRICAL SUPPLIES**

INSULATION, WIRE, VARNISHES, SUPPLIES, ETC. Send 3c stamp for bulletin. Auto Power, 414-C S. Hoyne Ave., Chicago.

**PATENT ATTORNEYS**

PATENTING INVENTIONS IS MY SPECIALTY through 28 years; Sterling Buck, Registered Patent Attorney 7180, 629 F. Washington, D.C. (Free Booklet-R).

**BUILD IT YOURSELF**

You can build this Trailer with ordinary tools easily from our step-by-step constructional sheets and large sized blueprints. Finest designed Trailer in existence, sleeps 4. Toilet, Shower, Electric Light, etc. Save 75% of the cost by building it yourself. Send 25c for plans sheet, illustrations and details.

**THE PLAN SHOP, 910 Palmolive Bldg., Chicago, Ill.**

**A MODERN TUBE TESTER**

(Continued from page 26)

"The limitation of possible plate current supply make it possible to test all classifications of tubes, as the heavier plate current type tubes automatically cause a voltage drop and a flattening of the curve at the pre-determined point. Whereas, the low plate current tubes do not cause such a voltage drop. This makes all classifications of tubes come within a reasonable distance of the pre-determined meter mark. (Variations are taken care of by shunts across the meter.)

"It may be well to add here that it is impossible to injure a tube under this test condition. The present emission-type testers 'drag the heart out' of the filament or cathode of many tubes. (It is possible to ruin tubes on the emission-type tester in less than 30 seconds.)

**THE TESTING CIRCUIT**

"The testing circuit is analyzed as follows: "The suppressor is always at ground potential during tests. The screen-grid is held at a lower potential than the plate, for all tubes.

"The oscillator and detector sections of pentagrid-tubes are tested separately, with the oscillator anodes acting as a plate, the same as in actual use, and each other element either in its proper circuit or else out of circuit.

"Rectifiers get a true relative test by their current flow and it may be well to add that the

method of test used in this unit causes perfect ionization of mercury-vapor rectifiers, with no bombardment and no injury. (In making tests on all mercury vapor tubes, even the 866, it will be noted that perfect ionization and true relative interpretation of the current flow are obtained.)

"Some tubes have a no-load test filament voltage in excess of their rating on this test apparatus, but under load the voltage drops to the correct value. This is due to the transformer design which gives great flexibility. Number 18 wire is used up to 7 1/2 V. and then No. 24 beyond. (Incidentally, the transformer has a 48-V. filament delivery, in anticipation of a future 48-V. filament tube. This voltage is wired to a terminal ready for use when such tubes appear.)

"In combination with the small plate current transformer output and a 40,000 ohm resistor, the diodes get decent treatment, with a test interpreting the cathode 'health'.

"Besides originating the English-reading scale in 1929 for tube testers, we originated the use of the 01A tube in adapting the D.C. meter for line voltage adjustment.

"(There is somewhat of a technical joker attached to the use of this tube. One of our competitors started use of the 01A for line voltage adjustment and hooked the grid to the plate for emission. This deteriorates the tube rapidly and the line voltage adjustment becomes something upon which no dependence can be placed.)

(Continued on page 55)

The circuit of the test unit described in this "letter."

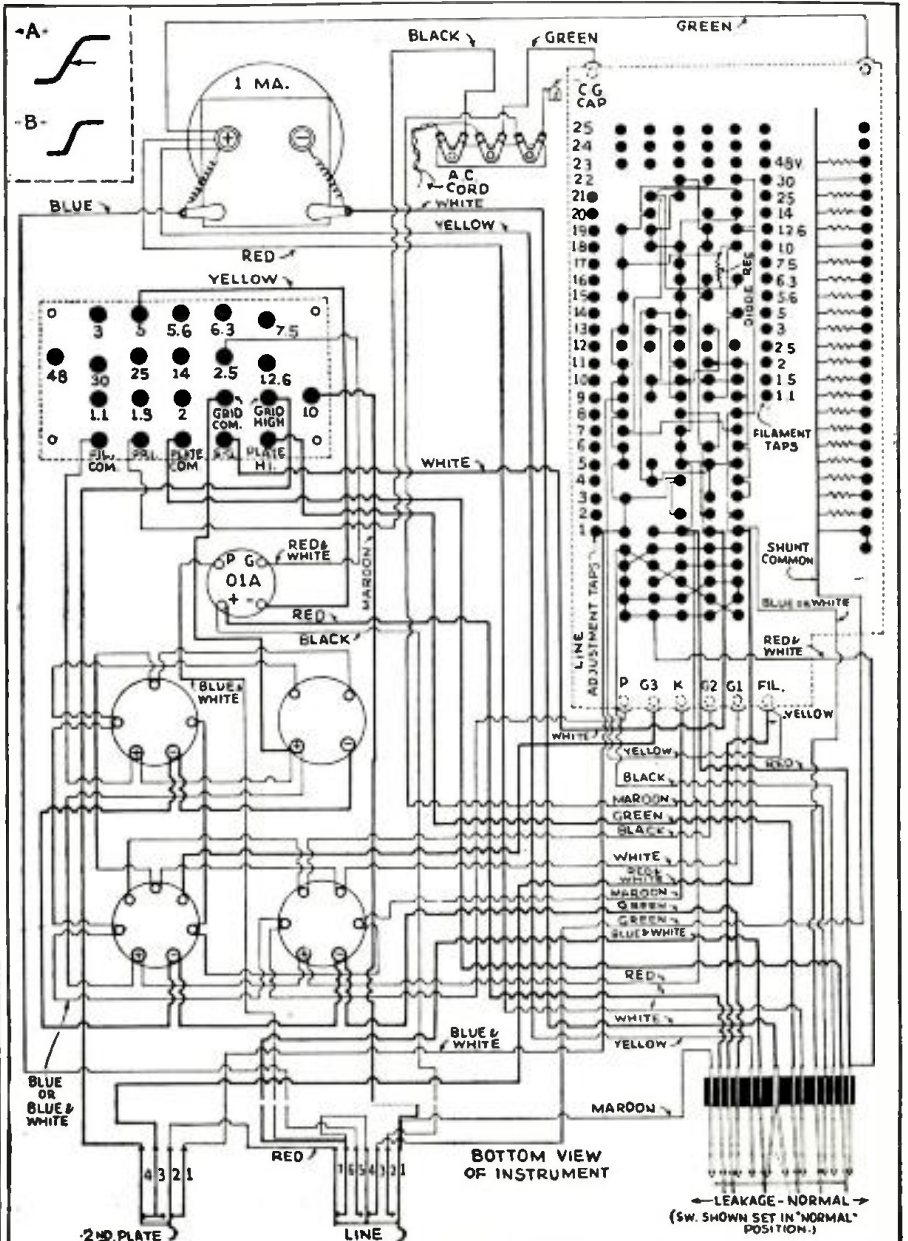

Please Say That You Saw It in RADIO-CRAFT



## HOW TO MAKE A D.C. TO A.C. METER CONVERTER UNIT

(Continued from page 26)

screw or any other part of the rectifier as disastrous results might follow.

The rectifiers are available with leads to eliminate the damage that might be caused by heat when soldering directly to the rectifier lugs. A circular disc of bakelite, drilled as shown in the photograph makes a convenient arrangement for mounting. Wire the unit in accordance with the schematic circuit shown. The housing is completed by adding a short length of bakelite tubing and a wood base covered with felt.

The diagram and List of Parts applies to a meter having a range of 0-0.5-ma., and an internal resistance of 110 ohms. Multipliers must be of other values for any different range and resistance of meter.

### LIST OF PARTS

- One bakelite disc, 3 3/4 ins. in dia.;
- One piece of bakelite tubing, 1x3 3/4 ins. in dia.;
- One wood disc;
- Five jacks, J1, J2, J3, J4, J5;
- One multiplier, 6,800 ohms, R1;
- One multiplier, 62,000 ohms, R2;
- One multiplier, .39-meg., R3;
- One multiplier, .63-meg., R4;
- One full-wave, copper-oxide rectifier;
- One name plate;
- Misc. screws, nuts, brads, felt, wire, terminals.

## HOW TO MAKE AN A.C.-D.C. I-TUBE "DEAF AID"

(Continued from page 27)

be considered, for instance, the "rising frequency characteristic" essential in deaf-aids for the average person.) The circuit is shown in Fig. 1; Figs. A and B show, respectively, the top and bottom of the chassis.

Following the circuit from input to output, we have first the microphone. This is a sensitive, high-grade, single-button type, made specially for this type of work. Input transformer T1 delivers a relatively large input to the tube grid. Output transformer T2 offers impedance of 50, 200, 500 ohms, and a number of combinations that may be used simultaneously to operate one or several headphones. (This feature makes this device adaptable to either individual or multi-aid use.)

The single headphone used—and known as "featherweight" on account of its extreme lightness—when used as an individual unit has an impedance of about 500 ohms; when used as a multi-unit in a church or theatre the impedance value required will depend upon the number of phones desired.

### LIST OF PARTS

- Two Aerovox condensers, 25 mf., type P.R. 50, C1, C2;
- Two Aerovox condensers, 8 mf., type B.P. 2, C3;
- One Aerovox condenser, 0.5-mf., type 1140; C4;
- One microphone\*, type A-sensitive, M;
- One Electrad volume control, type 205, R2;
- One Kenyon transformer, type B.L.G. T1;
- One Kenyon transformer, type B.P.L. T2;
- One Kenyon choke, type KC-200, Ch. 1;
- One Kenyon choke, type KOC, Ch. 2;
- One I.R.C. metallized resistor 1,500 ohms, 1/2-W., R1;
- One I.R.C. metallized resistor, 5,000 ohms, 1 W., R4;
- One line cord resistor\*, 322 ohms, R3;
- One drilled chassis and aluminum case\*;
- One single-pole power switch\*; Sw.;
- One single headphone\*; 500 ohms impedance;
- One Sylvania, Ken-Rad or National Union type 12A7 tube, V;
- One 7-prong socket (for tube V).

Note—the names of manufacturers of parts marked (\*) will be sent upon request.

The interior of the deaf-aid unit.

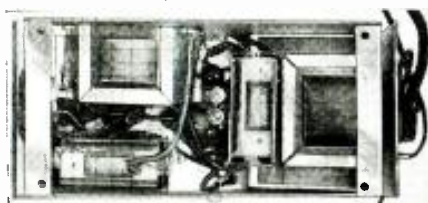

## THE NEED FOR A "TUBE ANALYZER"

(Continued from page 28)

pliable to present day multi-electrode tubes, as well as those of the older types.

The problem of making these three tests in a speedy efficient manner has been solved in the "English-reading" portable instrument shown in Fig. A. (A counter-type unit also is available; a panel design is shown in the preceding June issue of RADIO-CRAFT, page 725.)

A tube under test in the tube checker is "unsatisfactory" if (A) the ultra-sensitive neon bulb glows—if (B) there is cathode leakage—or (C) if the pointer of the "tube merit" meter remains in the "Replace" or "Weak" space of the English-Reading dial-scale plate. These results are plainly marked. The customer likes to see for himself whether his tubes are good or bad.

## RADIO RECEIVER CONNECTIONS FOR "CATHODE-RAY ALIGNMENT"

(Continued from page 28)

from between the plate of the detector tube and the negative side of the "B" circuit.

Connecting the Test Oscillator to the Receiver Being Aligned. The test oscillator output (it is assumed that some "frequency-wobbling" arrangement has been added to it) should be coupled to the control-grid of the tube preceding the I.F. stage under alignment. (For further details about "wobble" circuits and cathode-ray theory, the articles entitled "Fundamental Facts About Cathode-Ray Tubes" in the April and May, 1935, issues of RADIO-CRAFT should be read.) It is essential that this connection be made without altering any of the operating characteristics of this stage. If the grid of the tube to which connection is to be made is at zero D.C. potential with respect to ground, the oscillator should be connected to the grid of the tube and the lead which normally goes to this grid should be disconnected, the low side of the test oscillator output returning to the "chassis" ground. If the grid is not at zero D.C. potential with respect to ground, connect the high side of the oscillator to the grid (disconnecting the lead on the grid) and the other side to the "C—" lead for this grid.

The output of the second-detector may be connected to the cathode-ray tube and the oscillator may be connected to the aerial and ground terminals of the receiver. With this connection, the image on the screen of the tube will be the overall response of the receiver. Of course, the oscillator must be of the high-frequency type and the "wobble" condenser rotated by the motor must be small enough so that the frequency is varied only by about 20 kc. either side of resonance. This connection is used when the R.F. stages of a receiver are to be aligned.

## A MODERN TUBE TESTER

(Continued from page 54)

"We have from the beginning biased the 01A and have given it a reactivating filament voltage. We have instruments that have been in use for over 4 years with the 01A at original value. Each tube is 'cooked' before entry into the instrument; the meter shunt is then hand-calibrated to bring adjustment directly on the long line of the meter.

"The switching arrangement for testing leakages throws one element in series with the 01A rectifier and the meter, with all other elements tied together. Moving the slider in its short space gives each element its chance.

"The test is very sensitive, giving a meter reading exceeding two million ohms. (To keep from confusing the public, the switch which changes from normal test to leakage test, acts as a pole changer and the leakage readings are counter-clock wise on the meter.)

"The leakage readings are made cold, but due to the extreme sensitivity of the readings we have yet found a tube that develops a hot short that does not indicate a cold leakage on this sensitive device."

## Now—a high-powered—

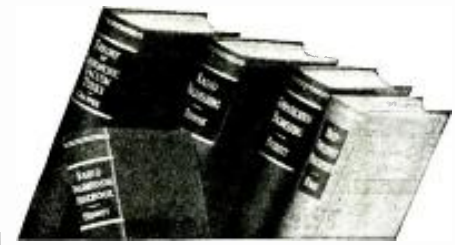

## Radio Engineering Library

—especially selected by radio specialists of McGraw-Hill publications

—to give most complete, dependable coverage of facts needed by all whose fields are grounded on radio fundamentals

—available at a special price and terms.

These books cover circuit phenomena, tube theory, networks, measurements, and other subjects—give specialized treatment of all fields of practical design and application. They are books of recognized position in the literature—books you will refer to and be referred to often. If you are practical designer, researcher or engineer in any field based on radio, you want these books for the help they give in hundreds of problems throughout the whole field of radio engineering.

5 volumes, 2981 pages, 2000 illustrations

1. Everitt's COMMUNICATION ENGINEERING
2. Terman's RADIO ENGINEERING
3. Chaffee's THEORY OF THERMIONIC VACUUM TUBES
4. Hund's HIGH FREQUENCY MEASUREMENTS
5. Henney's RADIO ENGINEERING HANDBOOK

10 days' examination. Special price. Monthly payments, \$26.00 worth of books cost you only \$23.50 under this offer. Add these standard works to your library now; pay small monthly installments, while you use the books.

### SEND THIS ON-APPROVAL COUPON

McGraw-Hill Book Co., Inc.  
330 W. 42nd St., New York, N. Y.

Send me Radio Engineering Library, 5 vols., for 10 days' examination on approval. In 10 days I will send \$2.50, plus few cents postage, and \$3.00 monthly till \$23.50 is paid, or return books postpaid. (We pay postage on orders accompanied by remittance of first installment.)

Name.....  
Address.....  
City and State.....  
Position.....  
Company..... RC-7.25

## THE Only 100% RADIO CATALOG

IT'S  
**Free**  
1935  
**RADIO**

THOUSANDS OF PARTS  
SET-BUILDING KITS  
TEST INSTRUMENTS  
PUBLIC ADDRESS  
SHORT WAVE GEAR  
ALL-WAVE AUTO  
BATTERY RADIOS

## ALLIED RADIO CORPORATION

833 W. Jackson Blvd., Chicago, Ill. Dept. D  
Send me your FREE Spring & Summer Catalog.

Name.....  
Address.....

## TRANSFORMERS

MADE TO ORDER OR REWOUND

Write for Prices!

CARMI TRANSFORMER WORKS  
202-204 Staley St., Carmi, Ill.

Please Say That You Saw It in RADIO-CRAFT



**There's plenty of SERVICING MATERIAL in the 1934 Manual!**

Radio Service Men and others engaged in various branches of radio know the importance of the GERNSBACK Manuals, and how much they depend on them for reliable information. Whether for public address work, receiver diagrams or tube information, the material needed is certain to be found in one of the volumes of the OFFICIAL RADIO SERVICE MANUAL.

**Contents of the 1934 Manual in Brief**

Diagrams and service notes, more complete than ever before in any manual. Voltage readings for practically all sets, as an aid in checking tubes and wiring. All values of I.F. transformers used in superheterodynes, with the manufacturers' own suggestions as to correct balancing. A complete compilation of radio tube data, covering both old and new types. A complete list of American broadcast stations with their frequencies in kilocycles; extremely useful in calibrating test oscillators and receivers. Free question and answer service. No theory; only service information in quickly accessible form. A handy, easily-consulted master index making it easy to find almost anything pertaining to service problems. Instantly. This index includes all the diagrams published in all the previous GERNSBACK manuals, as well as the 1934 diagrams. A big convenience and time saver.

**400 PAGES**

**Over 2,000 ILLUSTRATIONS**  
**9x12 Inches**

**Flexible Looseleaf Leatherette Cover**

Send remittance of \$3.50 by check, money order or unused U. S. Postage Stamps. Register letter if it contains cash or stamps. MANUAL SENT POSTAGE PREPAID.

GERNSBACK PUBLICATIONS, Inc.  
99R Hudson Street, New York, N. Y.

**A MAGAZINE WHICH NEEDS NO INTRODUCTION TO SHORT-WAVE FANS**  
**SHORT WAVE CRAFT**

This popular monthly magazine, **SHORT WAVE CRAFT**, contains everything you want to know about Short Waves. The wonders of world-wide short-wave reception are clearly described and illustrated. Latest practical information for radio fans, experimenters and "hams" will be found. Tells you how to build short-wave receivers and transmitters; construct sets of one and two tubes or as many as seven, eight or more. Tells best foreign stations to use and when to tune them—includes newest and best circuits of the time. **SHORT WAVE CRAFT** is edited by Hugo Gernsback.

**NEW FEATURE RECENTLY ADDED**—To the short wave fan who has logged and obtained verification of the largest number of short-wave stations from all over the world during one month, will be awarded a magnificent 24" silver trophy.

**Special This Month Only!**

For the month of June only, we offer readers of this magazine the opportunity to read radio's greatest short-wave magazine at a special saving. The regular subscription price is \$2.50 per year. You can now get **SHORT WAVE CRAFT** for the next

**8 MONTHS FOR \$1.00**

4-Color Cover  
Over 200 illustrations  
9x12 inches in size

**25c** The Copy  
ON ALL NEWSSTANDS



Send remittance by check, money order or U.S. Postage Stamps. Register letter if it contains cash or currency.

**SHORT WAVE CRAFT**  
99R Hudson St. New York, N. Y.

**VALUABLE "DECIBEL" DATA**

(Continued from page 27)

following additional step must be taken:

For voltage ratios, move the decimal point one point right for each 20 db; in other words, if we have a ratio of .00041, move the decimal point three figures to the right, making .41 and add 60 db. to the db. equivalent of .41 (7.74 db.). This gives us a total of 67.74 db.

For power ratios, the same method applies, except that the decimal point is moved one figure to the right for each 10 db.

The above data is referred to the electrical side of our audio amplification system only. Inasmuch as our modern speakers do not vary extremely in efficiency, a fairly definite relationship holds between the electrical output and actual acoustic output. This fact has been used in developing an interesting chart (Fig. 2) which illustrates the minimum power requirements of P.A. equipment, for intelligibility as compared to the maximum distance of the audience from the reproducers. The surrounding noise level has a great bearing upon the output requirements. This is indicated in Fig. 2 by separate curves A, B and C which represent power requirements for different external noise levels.

The statement previously made regarding the logarithmic sensitivity of the ear is readily substantiated in the fact that a sound level readily heard in a quiet town is not sufficiently great to be audible over the same area in a noisy city. It is seen from the curves of Fig. 2 that a sound source will cover in an average residential district more than 2½ times the distance it would cover in city traffic. Compared to very quiet areas, such as open country with no traffic, the difference is even more apparent. Power which is satisfactory over a mile distance under such conditions would barely be suitable for one-half an average city block.

In many cases, therefore, amplifiers have to be constructed for use at various locations at different times. This is particularly true in the P.A. field. Consequently, for satisfactory operation under the worst normal conditions, an amplifier must have comparatively high power output. To cover a distance of 150 feet under noisy conditions, as per Fig. 2, curve C, 35 watts of electrical audio power would be required. Assuming that the input to an amplifier of this power rating is -50 db. (this is average microphone input), we can readily use the chart of Fig. 1 to determine the requisite gain in a P.A. amplifier of this type. Looking at the chart, we find that 35 W. output is approximately + 38 db. Therefore, 38 db. minus -50 db. gives an overall requisite gain of 88 db.

The schematic circuit of a high-quality P.A. amplifier capable of delivering 38 W. of "clean" audio suitable for such service is analyzed as follows.

The high output power is obtained through the use of four type 45 tubes operated A prime in the output stage. Fixed bias for the output tubes is obtained through the use of a separate type 45 tube as a rectifier. Individual bias control allows the plate current of the pairs of output tubes to be balanced for minimum hum and distortion. High gain and low distortion are obtained in the balance of the amplifier through the use of two push-pull, transformer-coupled stages. Type 57 triodes are used in the first stage, and through their high amplification factor (20) and transformer coupling permit high gain with triode tubes. The 56s used in the second push-pull stage are coupled through a special driver transformer to the output tubes. Perfect matching between this driver transformer and the output transformer is essential for low harmonic content. The overall gain then is 90 db.

(The writer will be glad to advise further concerning this, or other, high-power amplifiers for securing a particular gain, and power output.)

TABLE I

db.	$\frac{I_2}{I_1}$	$\frac{P_2}{P_1}$
0	1.00	1.00
.18	.98	.96
.35	.96	.92
.54	.94	.884
.72	.92	.846
.92	.90	.81
1.11	.88	.774
1.31	.86	.74
1.51	.84	.706
1.72	.82	.672
1.94	.80	.64
2.16	.78	.608
2.36	.76	.578
2.62	.74	.548
2.85	.72	.518
3.10	.70	.49
3.35	.68	.462
3.61	.66	.435
3.88	.64	.41
4.15	.62	.384
4.44	.60	.36
4.73	.58	.336
5.04	.56	.314
5.35	.54	.292
5.68	.52	.27
6.02	.50	.25
6.34	.48	.23
6.69	.46	.21
7.06	.44	.19
7.42	.42	.17
7.81	.40	.16
8.21	.38	.15
8.62	.36	.14
9.05	.34	.13
9.50	.32	.12
9.97	.30	.11
10.46	.28	.10
10.97	.26	.09
11.50	.24	.08
12.05	.22	.07
12.62	.20	.06
13.21	.18	.05
13.82	.16	.04
14.45	.14	.03
15.10	.12	.02
15.77	.10	.01
16.46	.08	.01
17.18	.06	.01
17.92	.04	.01
18.69	.03	.01
19.49	.02	.01
20.32	.01	.01

Fig. 1, below. A chart for determining the gain of P.A. amplifiers. The horizontal lines represent decibel units and the vertical lines the power output in watts. All additions should be made algebraically.

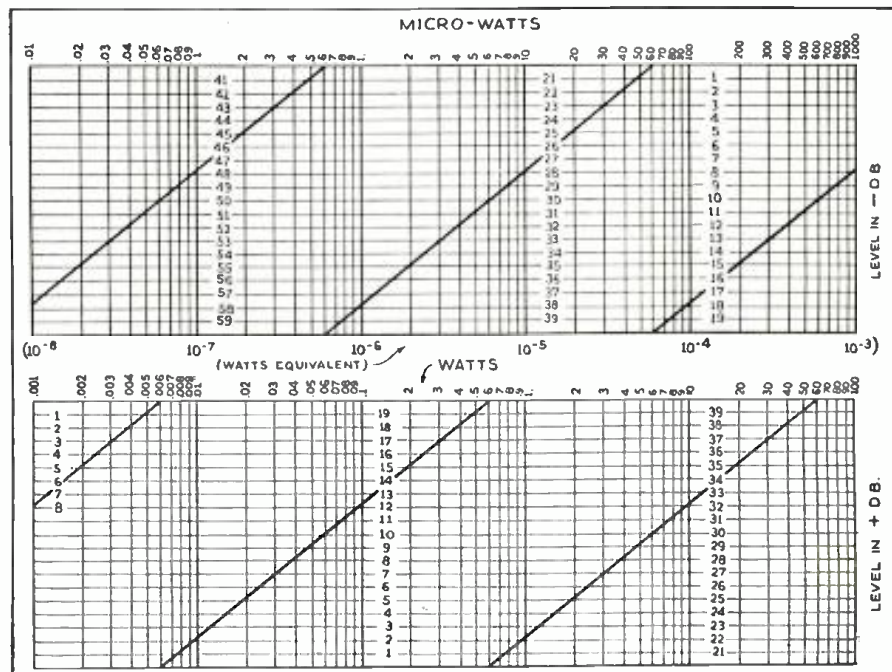

Please Say That You Saw It in RADIO-CRAFT



# THE LISTENING POST FOR ALL-WAVE DX-ERS

(Continued from page 31)

ture," and relate some of the unforgettable thrills of reception encountered in the "shack.")

## BROADCAST BAND NEWS

There has been a complete reallocation of all broadcast-band channels in Australia to take effect September 1st, 1935. This complete new set-up will be given in its entirety in the August issue of RADIO-CRAFT. It is believed that with this new station distribution, and with the several powerful new stations that will be in operation, next fall should be a veritable DX holiday for North Americans seeking 'Aussies! Before these allocations come into force the following new stations will take the air: 4WK, Warwick on 900kc., 7BU Burnie on 1,360kc., 4CA Cairns on 1,450kc., and 2TM Tamworth on 1,490kc.

Radio service on a regular basis was inaugurated in Egypt on May 31st, 1934 from a 20 kw. station at Abu Zaabal near Cairo. This station operates on 620kc. The other main station is Alexandria I, a 500 watt station on 1,122kc. Because of the ever growing requirements of radio listeners in Egypt an alternative service is now provided from Cairo II a 500 watt station on 1,348kc., and Alexandria II, a 500 W. station on 1,429kc. The erection of relay stations in upper Egypt is also contemplated.

The broadcast station in Reykjavik, Iceland which is a 16 kw. transmitter on a long wave of 1,200 meters is to be raised in power to 100 kw. This station will be relayed by the new short-wave transmitter recently installed.

## CUBAN BROADCASTERS

As an item of very general interest we present the latest Official List of broadcasting stations in Cuba, through the courtesy of Mr. Alec Kinghorn of Havana. CMX was completely destroyed some time ago by eight armed men but they will soon be on the air again with a new installation.

Call	Freq.	Power	Location and Address
CMW	640	1,000	Sr. Juan de Dios Carreno, Marti No. 103—Havana
CMBX	640	125	Sra. Calleja—Estefani, Infanta No. 132—Havana
CMCX	1,090	250	Sr. Juan de Dios Carreno, Marti No. 7—Guantanamo—Havana
CMCQ	650	250	Sr. Andres Martinis, Vista Alegre No. 80—Vahora—Havana
CMCF	730	250	International Broadcasting Co. Primera y 8—Havana
CMCW	750	117	Sr. A. D. Cervantes, San Lazaro No. 113 Ewa Galindo—Havana
CMBS	770	130	Sr. Enrique Artalejo, Calzada y H—Vedado—Havana
CMOA	790	72	Sr. Juan Fernandez Duran, Aguilar No. 120—Havana
CMCF	815	250	Sr. Raulo Karman, Bayo No. 67—Havana
CMQ	840	500	Sr. Miguel Gabriel, Calle 25 No. 445—Vedado—Havana
CMX	920	650	Sr. Francisco Lavin, Oficina y Obrapia—Havana
CMBC	940	195	Sr. Domingo Fernandez, Maximo Gomez No. 139—Havana
CMCD	960	190	La Voz del Aire, Calle 25 y G—Vedado—Havana
CMBZ	1,080	120	Sres. M. y G. Sulas, San Rafael No. 14—Havana
CMY	1,090	1,000	Sr. M. D. Antran, Cile G. No. 215—Vedado—Havana
CMK	1,060	1,500	Ciudad Nacional de Radio S. A.—Hotel Plaza—Havana
CMCO	1,110	150	Sr. Enrique Lasanta, Oficina—16—Havana
CMBG	1,140	325	Mr. John L. Stowers, Hospital No. 100—Havana
CMBD	1,170	163	Sr. M. D. Antran, Calle 17 y—Vedado—Havana
CMCI	1,200	500	Sr. Rafael Rodriguez Esteyne No. 4—Havana
CMCR	1,230	112	Sr. Antonio Capablanca O'Reilly y Aguilar—Havana
CMCG	1,255	162	La Voz de S. A. Madero No. 340 Alamo—Havana
CMCC	1,250	182	Sr. Jorge Garcia Serra, San Francisco No. 13—Vahora—Havana
CMOX	1,320	250	Sra. Perez, 4 Lushada, Calle 10 entre 17 y 19—Vedado—Havana
CMCA	1,350	435	Sr. Antonio Tovar, Galiano No. 102—Havana
CMBX	1,380	171	Sr. Alberto Alvarez, San Miguel No. 194—Havana
CMCR	1,410	122	Sr. Aurelio Hernandez, Mibares No. 35—Vahora—Havana
CMOK	1,470	184	Sr. Rafael Valdes, Marquez Gonzalez No. 52—Havana
CMCN	1,500	162	Sr. Antonio Girard, Reina y Buen Retiro—Martinez—Havana

Call	Freq.	Power	Location and Address
CMIR	750	150	Ciudad Nacional de Radio S. A.—Finlay No. 3—Cruces
CMHW	810	100	Sr. Ramon Gonzalez—Arguelles No. 200—Cruces
CMIC	1,010	50	Sr. Rafael Valdes—Mareo No. 1—Camaguey
CMHA	1,070	50	Sr. Abelardo Menocal—Carrillo No. 31—Camaguey
CMGF	1,120	100	Sr. Berthold de la Torre-Giral Betancourt No. 51—Matanzas
CMH	1,130	45	Sr. Alberto Ganan—Independencia No. 95—Ciego de Avila
CMHF	1,150	200	Mr. John L. Stowers—Republica No. 54—Camaguey
CMHJ	1,180	100	Sr. Romulo Ucalde—Sta. Elena No. 104—Camaguey
CMIG	1,180	50	Sr. M. D. Sarandout—Mareo y C. Central—Ciego de Avila
CMHI	1,210	150	Sres. Laxiz y Paz—Independencia No. 34—Cruces
CMHR	1,240	30	Sr. V. E. Weiss y Cia. S. C.—Independencia No. 33—Santiago Spiritus
CMJE	1,250	50	Sr. Manuel Fernandez—Inoa Aguero No. 2—Camaguey
CMKE	1,250	150	Sra. Pineda, Bulboa y Cia. J. A. Saco No. 23—Ciego de Avila
CMHD	1,270	250	Sr. Manuel Alvarez—Maria Escobar No. 17—Camaguey
CMHK	1,320	250	Sr. Virginia Villanueva—Heredia No. 61—Cruces
CMHJ	1,360	50	Sr. Luis Marauri—H. Castillo No. 37—Ciego de Avila
CMGE	1,370	30	Sr. Casanova Sabater—Cepeades No. 180—Cardenas (Reserved by the Communication Department)
CMJC	1,360	150	Sr. Felix Sanchez—Cianero y Gral Gomez—Camaguey
CMGC	1,400	100	Sr. Oscar N. Mechoso—Independencia No. 56—Matanzas

CMGI	1,420	30	Sr. Armando Lizama—Marti No. 35—Colon
CMJP	1,430	75	Sr. Cesar Canales—Calleja No. 28—Moron
CMKP	1,460	30	Sr. Manuel J. Gongora—Liberad esq. Ariza—Holuquin

**Short-Wave Stations in Havana**

CMPN	1,712	700	Cap. Jose Lara—Jefatura de la Policia Nacional—Empedrado y Monterrey—Havana
COC	6,010	300	Sr. Luis Casas, San Miguel No. 88—Havana
COH	9,428	150	Sr. Hector Zayas Bazaan—Calle B No. 2—Vedado—Havana

## HIGH-FREQUENCY HIGH-LIGHTS

PCJ, Eindhoven, Holland "The Flying Dutchman" 19.71m. provided by far the most consistent short-wave reception of any station on the 19-meter band during the month of April as they were on the air daily. On April 28th PHH returned to its summer wavelength of 16.88 meters.

The Budapest, Hungary short-wave stations have announced the following change in schedule. IAS3, 15.370kc. each Sunday 9:00-10:00 a.m. E.S.T. HAT4 9.125kc., each Sunday from 6:00-7:00p.m. E.S.T. Address reports to Radiolabor, Budapest, Gyali-ut 22, Hungary.

W1XAZ, of Springfield Mass. is now using the call of W1XK experimentally.

VPD, of Suva, Fiji's has changed its call to VP-1A and operates on 22.94m. daily from 12:30-1:30 am E.S.T. Address Short-Wave Station VP-1A-C/O Amalgamated Wireless (Asia) Ltd., Suva, Fiji's.

HP5J, "The Voice of Panama". Panama, give their schedule as 7:30 to 10:00pm Panama Time. They operate on 31.28m.

It is reported that soon Persia will join the ranks of other Nations having up to date radio facilities with the immediate erection of stations at Teheran, Tchask, and Schiras. Thus one of the few remaining places that does not possess radio communication equipment will lose its isolation.

Norway's new Seven Year Plan incorporates the erection of a Norwegian State short-wave broadcasting station at Lamberstet, near Oslo, with a power of 25 kw. This would place Norway in the running with the other great empire broadcasting services of the World.

In conjunction with the N.B.C., the National Geographic Society plans another and more ambitious stratosphere ascent for the early part of June. This will take place at Rapid City, South Dakota, the same as last year and a more powerful short-wave transmitter, with a range of about 2,000 miles will be part of the regular equipment of the balloon. All short-wave listeners are invited to listen to the balloon's transmissions.

Several Spanish stations are being heard in the evenings on the 25 meter band. HJ4ABA announcing as Medellin, Colombia is being heard on about 11.70 mcs. YV5RMO "Maracaibo, Venezuela" is also coming in on the low-frequency end of the 25-meter band on about 11.68 mcs. Then up at the other end of the band and heterodyning W8XK at times is HJ4ABE of Medellin, Colombia. There is some conjecture if the last two mentioned are original frequencies, or harmonics of their 49-meter band transmissions. (At any rate these broadcasts are proving the feasibility of the South American stations using this band for static-free transmissions in the summer time—ED.)

HJ2ABC, that little station of Cucuta, Colombia which came in so well during the winter on 51.11 meters has a power of only 50 watts.

Russell Bills, our star reporter in Elkhart, Indiana reports that "ZLT" on 27.3 meters is working fine in the WEE hours. "They were heard QSA3/R6 recently from 1:09 to 1:21am C.S.T. At exactly 1:13am they called 'Hello Hello, Hello, Tokyo, etc'. Have since heard them several times at about this hour. I am also finding V1K on 30.75 m. They are being heard most anytime after midnight up to about 4:00am."

Mr. C. H. Hodge, of Huntington Park, Calif. writes that PLE, Bandoeng, Java 15.93 M. is on nearly every afternoon from 4:00-5:00pm P.S.T. talking with Tokyo, and KWU in Dixon, California.

For those who have not yet logged a Japanese commercial, we would recommend you tune for JVF, Nazaki, on 19.19 M. at exactly 3:45pm E.S.T. as they call KWU, Dixon, California, on 19.52M. at this time daily. Mr. Herman Kochmider of Bloomington, Ill., reports this schedule to us.

Mr. Guy Bigbee of Ft. Benning, Georgia, writes that SUV, Cairo, Egypt, can be heard now with clear reception but not very good volume testing with DGU in Berlin from 3:30 to 4:30pm E.S.T. The Berlin station uses music (Continued on page 62)

# SERVICE DEALERS! Check this List



Pick out what you need to bring your equipment up to the minute.

You can get all of these items free with National Union radio tube purchases. Find out how—Check items you want. Paste the list on a penny post card or slip it in an envelope and mail it now!

### HOW CAN I GET:

- A Tube Tester
- Service Manuals
- An All Wave Oscillator
- A Signal Generator
- A Multirange Meter
- A Set Analyzer
- An Oscillograph
- A Frequency Modulator
- A Tube Carrying Case
- A Coverall Work Coat

RC785

Name \_\_\_\_\_  
Street \_\_\_\_\_  
City \_\_\_\_\_ State \_\_\_\_\_

Check—Clip—Mail to  
NATIONAL UNION RADIO CORPORATION of N.Y.  
570 Lexington Avenue, New York, N.Y.



## Noise Killer!

Plugs into outlet . . . wall plate screws hold and ground . . . takes noisy-appliance plug . . . blocks man-made static from getting into house wiring and causing radio interference. Only \$1.75 list! Also male-female plug type for devices with long extension cord. \$2.25 list!

FREE CATALOG covers Aerovox line of condensers and resistors. Also sample copy of Aerovox Research Worker. See line at your dealers!



# Ken-Rad Radio Tubes

DEPENDABLE LONG LIFE

Ken-Rad Radio Tubes are made to give clear, dependable reception. They satisfy customers and build good will for dealers. Write for full information.

THE KEN-RAD CORP., Inc., Owensboro, Ky.  
Division of The Ken-Rad Tube and Lamp Corp.  
Also Mfrs. of Ken-Rad Incandescent Electric Lamps

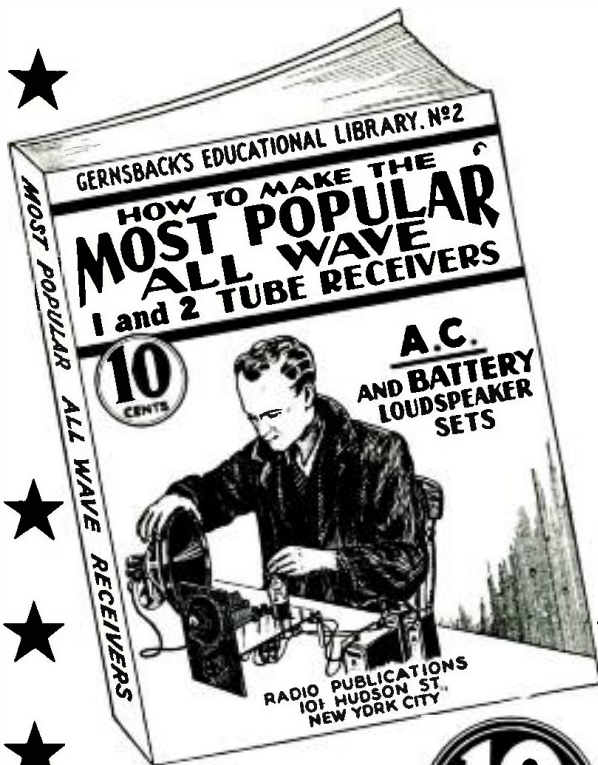

RADIO PUBLICATIONS RC-7-35  
103 Hudson Street, New York, N. Y.  
Please send immediately your book  
"HOW TO MAKE THE MOST POPULAR  
ALL-WAVE 1- AND 2-TUBE RECEI-  
VERS," for which I enclose 10¢ (coin or  
U. S. stamps acceptable). Book is to be  
sent prepaid to me.



Name.....  
Address.....  
City..... State.....

# NEW! NEW!! Just Out-

THERE has been a continuous demand right along for a low-priced book for the radio experimenter, radio fan, radio Service Man, etc., who wishes to build 1- and 2-tube all-wave sets powerful enough to operate a loudspeaker. Sets of this type are always intensely popular with all classes of people who not only wish to amuse themselves to see how good a set they can build with a single or two tubes, but frequently such sets are important for special purposes, particularly where a good little set is required and where space is at a premium. For the thousands of readers who wish to build such sets, this book has been especially published.

## HOW TO MAKE THE MOST POPULAR ALL-WAVE 1- AND 2-TUBE RECEIVERS

This book contains a number of excellent sets some of which have appeared in past issues of RADIO-CRAFT, and have been highly successful. These sets are not toys but have been carefully engineered. They are not experiments. To mention only a few of the sets the following will give you an idea.

- The Mexadyne 1-Tube Pentode Loudspeaker Set, by Hugo Gernsback.
- Electrifying The Megadyne. • How To Make a 1-Tube Loudspeaker Set, by W. P. Chesney. • How To Make a Simple 1-Tube All-Wave Electric Set, by W. Green. • How To Build A Four-In-Two All-Wave Electric Set, by J. T. Bernsley, and others. Not only are all of these sets described in this book, but it contains all of the illustrations, hookups, etc.—the book, in fact, contains everything. Nothing at all has been left out. A wealth of important detail is presented in this book that will make you wonder how we can do it at the price. And believe it or not, the book contains over 15,000 words of new legible type. The book is thoroughly modern and up-to-date. It isn't just a reprint of what was printed before. All the latest improvements have been incorporated into the sets. Remember that this book sells at the extraordinary low price of ten cents; you can not possibly go wrong in buying it. Despite its low cost, our usual guarantee goes with this book as well!

**IF YOU DO NOT THINK THAT THIS BOOK IS WORTH THE MONEY ASKED FOR IT, RETURN IT WITHIN TWENTY-FOUR HOURS AND YOUR MONEY WILL BE INSTANTLY REFUNDED.**

There has never been such a wealth of data published in a low-priced radio book of this type in the history of the radio publishing business.

Take advantage of the special offer we are making and use the coupon at the left.

## RADIO PUBLICATIONS

103 Hudson Street,

New York, N. Y.

### A BEGINNER'S SHORT-WAVE CONVERTER

(Continued from page 29)

latter is shunt fed through the R.F. choke, and condenser coupled through C6 into the aerial circuit of the broadcast receiver.

The power pack is a full grown system using a type 80 rectifier V4 and plenty of filtering in the form of choke T3 and condensers C7 and C8.

A special three-foot length of shielded cable is provided to connect the output of the converter to the input posts of the B.C. receiver. Providing the latter itself has good shielding, this cable prevents pick-up of broadcast signals when the converter is in use. Pick-up of this kind is very annoying and is common with unshielded leads.

The primaries of all the short-wave coils on the tuner section are brought out (through the switch, of course) to individual binding posts, which allow the use of a transposed or twisted feeder line with doublet antennas of the "noise reducing" type. If an ordinary aerial is used, one of these posts is grounded to an adjacent post.

The completed converter measures 10 x 7½ x 7 ins. high overall. The chassis is of rigid steel, finished in crystalline black. The tuning condenser is controlled by a smooth action vernier dial and is mounted on soft rubber feet to overcome microphonic effects. At the left is the on-off switch; at the right, the wave changing switch. Volume is controlled by the regular volume control on the broadcast receiver.

In operation, this converter shows that it is a real instrument, not a mere makeshift. Connected in less than a minute to a popular mid-gate receiver, with the latter tuned to 540 kc., it immediately brought in Berlin and London in downtown New York, and also numerous amateurs and airplanes. Later in the evening it produced powerful signals from half a dozen Central and South American short-wave broadcasters. The tuning is simple and altogether uncritical.

### HOW TO MAKE A NOVEL I-TUBE BATTERY SET

(Continued from page 29)

About the only caution that need be stressed, is the admonition that rheostat R4 be adjusted to limit the filament voltage to not more than 2 V. This is conveniently done by having previously scratched on the panel a short mark indicating the correct setting when the "A" battery is fresh, as checked by a filament voltmeter reading.

The writer has not had much opportunity to "play" with this set, but experiments to date show interesting possibilities. The use of plug-in coils makes it convenient to check performance of the set on all waves.

Don't worry about bypass condensers C3 and C4, if you don't have 'em around—they may be left out of the circuit without causing any great difficulties. On the other hand, it is essential that coil L2-3 have sufficient turns to produce regeneration; reverse connections 2-3 if the circuit does not regenerate at all.

Experiment to determine the "B" voltage maximum best suited to the individual tube and set; try 67½ V., for instance.

If additional selectivity is required, connect a second, 140 mmf. mid-gate tuning condenser in series with the antenna, as indicated at CX.

Watch for the audio amplifier to be described in a forthcoming issue of RADIO-CRAFT. It will be battery operated, and may be used with any battery-type receiver.

#### LIST OF PARTS

- One Hammarlund 140 mmf. mid-gate tuning condenser, C1;
- One Aerovox mica dielectric condenser, 250 mmf., C2;
- One Aerovox mica dielectric condenser, 250 mmf., C3;
- One Aerovox paper condenser, 0.25-mf., C4;
- On Electrad volume control, 0.5-meg., R1;
- One Electrad volume control, 50,000 ohms, R2;
- One plunger-type gridleak, R3;

- One Electrad rheostat, 30 ohms, with switch Sw., R4;
- One Hammarlund kit of all-wave plug-in coils, L;
- One Hammarlund 6-prong socket, for L;
- One Hammarlund 5-prong socket, for V;
- One Sylvania type 33 tube, V;
- One 6¼ x 7 in. metal panel;
- One 4 x 7 x ½-in. thick wood baseboard;
- Misc. hardware.

### NOW AVAILABLE — FREE ADAPTER FOR METAL TUBES

If you own a Triumph model 400 tube tester be sure to send to them at once for your free "Metal Tube" Adapter and Test Chart Data! The 8-prong adapter eliminates any need for rewiring the tester in order to permit testing all tubes on the market, including the new "all metals."

The definite advent of "metal" tubes (See RADIO-CRAFT, June 1935.) has made it imperative that Service Men avail themselves of every bit of aid in respect to the service angle they present, and every Service Man owning tube test apparatus made by Triumph Mfg. Co. undoubtedly will appreciate their cooperative gesture.

Please Say That You Saw It in RADIO-CRAFT



## THE "ULTRA-MODERN SUPER-HET" NOW ALL-WAVE

(Continued from page 33)

band switch controls the connections of thirty different coils, since each stage and the oscillator have two coils per transformer. Each transformer has all of its coils switched independently to prevent the formation of dead spots and the absorption of energy from a circuit in use by some other coil circuit not in use.

### THE BEAT OSCILLATOR

Considerable work was done on the development of a suitable beat oscillator that could be incorporated in a receiver of this type, with the least cost and greatest ease; for it must be remembered that this receiver was designed for construction by radio enthusiasts who want the most for the least expenditure of cash.

Using a 6F7 solved the problem very neatly. The high-gain section is used as an I.F. amplifier, and the triode section as the beat oscillator; the coils for which are labeled BO in the schematic diagram. The variable condenser shown is adjustable by the user for any desired beat frequency.

### A.V.C. AND A.F. AMPLIFIER

Automatic volume control is highly desirable in any short-wave receiver with sufficient sensitivity to pick up and reproduce weak signals. Two diode plates are used in a half-wave circuit, and the audio amplifier portion of the same tube (a 6B7) is self biased. A study of this portion of the diagram will show that the diode and pentode sections are resistance-capacity coupled by resistors R14 and R7 and condenser C1. Resistor R7 is the manual volume control.

Of particular interest is the A.F. amplifier. Plate voltage on the 6B7 is secured through resistor R8, and the primary of the A.F. transformer is connected to the plate, through an isolating condenser C5; thus, no D.C. flows through the primary of the A.F. transformer. This means that the core has zero D.C. flux density at all signal levels, and the impedance of the primary of the transformer is substantially uniform from the weakest to the strongest signals reproduced. This condition is in direct contrast to some receivers which have the plate current flowing through the primaries which, therefore, change their inductance with every change in signal level.

Low-frequency response is obtained by tuning the primary inductance, by suitably choosing the value of C5. It is to be noted that this can be done only if the primary inductance has a substantially constant value.

It is well now to revert to the oscillator tube and discuss the padding circuit used and the wave range covered in each band. The padding condenser is shown as C11, a single condenser. Condenser C11 is composed of a fixed condenser on two bands, of a fixed and a variable condenser on one band, and of all-variable condensers on two bands, as per the following table.

Wave Band In Mc.	Fixed Capacity In Mmf.	Variable Capacity In Mmf.
10.4-25	5100	— (C11E)
4.0-11.5	2250	— (C11D)
1.478-4.0*	1000	200 (C11C)
.55-1.525	—	500 (C11B)
.1485-40	—	100 (C11A)

(\*The fixed and variable padders are connected in parallel.)

### OPERATION

This receiver has been in actual operation for one month, night and day. Stations from all parts of the world and on all wave bands have been received with remarkable intensity. The crowded 49-meter and 31-meter bands were listened to with musical appreciation as well as with a critical ear. The dial used is of the two speed type with two control knobs mounted on a split-shaft drive. The large knob is for fast tuning and the smaller knob for convenient tuning in the high frequency bands.

Resistors R4 and R5 are the bleeder resistors across the high D.C. voltage, and R4 also serves to drop the plate voltage to the required value for screen-Grids—about 100 volts. The beat oscillator switch, used to control the BO is bypassed by C5. One of the filter condensers, C10, is also bypassed by a paper condenser, C6, of small value, as any high frequencies that may find their way into the power unit cannot be effectively bypassed by electrolytic condensers.

### LIST OF PARTS

- Four 1 meg. resistors, 1/2-W., R1;
  - Three 300 ohm 1/2-W. resistors, R2;
  - One 4000 ohm 1/2-W. resistor, R3;
  - One 10,000 ohm 2 W. resistor, R4;
  - One 20,000 ohm 2 W. resistor, R5;
  - One 50,000 ohm 1/2-W. resistor, R6;
  - Four .1-meg. 1/2-W. resistors, R7;
  - One .25-meg. 1 W. resistor, R8;
  - One 2 meg. 1/2-W. resistor, R9;
  - One 50,000 ohm 1 W. resistor, R10;
  - One .5-meg. 1/2-W. resistor, R11;
  - One .1-meg. 1 W. resistor, R12;
  - One 50,000 ohm potentiometer and switch, R13;
  - One .5-meg. potentiometer, R14;
  - One 3-gang tuning condenser, 365 mmf. per section, C1, C2, C3;
  - Eight .1-mf. 200 V. paper condensers, C4;
  - Four .1-mf. 400 V. paper condensers, C5;
  - One .1-mf. 600 V. paper condenser, C6;
  - One .05-mf. 400 V. paper condenser, C7;
  - One .5-mf. 400 V. paper condenser, C8;
  - One 8 mf. 500 V. electrolytic condenser, C9;
  - One dual-8 mf. electrolytic condenser, screw bottom, C10;
  - One 100 mmf. adjustable condenser, C11A;
  - One 500 mmf. adjustable condenser, C11B;
  - One .001-mf. fixed mica condenser and 250 mmf. adjustable mica condenser, C11C;
  - One .002-mf. fixed mica condenser and one 250 mmf. fixed mica condenser, C11D;
  - One .005-mf. fixed mica condenser and one 150 mmf. fixed mica condenser, C11E;
  - Three 250 mmf. fixed mica condensers, C12;
  - One 100 mmf. fixed mica condenser, C13;
  - One 10 mf. condenser, C14;
  - One 10 mmf. mica condenser, C15;
  - One antenna input coil with five sections, L1;
  - One first-detector set of R.F. coils, L2;
  - One set of oscillator coils, L3;
  - One 456 kc. I.F. input transformer, 1FT1;
  - One 456 kc. I.F. output transformer, 1FT2;
  - One beat oscillator coil for 6F7, BO;
  - One BO rotary snap-switch, SW8;
  - One audio input transformer, 2:1 ratio, T1;
  - One three gang, six pole, five position wave-band switch, SW1, SW2, SW3, SW4, SW5, SW6;
  - One 6D6 socket;
  - One 6A7 socket;
  - One 6F7 socket;
  - One 6B7 socket;
  - Two 6B5 sockets;
  - One 5Z3 socket for rectifier tube;
  - One 5-prong plain socket for speaker plug;
  - One 5-prong plug for speaker plug, P1;
  - One 8 1/2 in. dynamic speaker with 1100 ohm field coil;
  - One power transformer to deliver 340 V. D.C. to filter choke, 5 V. A.C. for the 5Z3 rectifier tube, and 6.3 V. for the receiver tubes;
  - One stamped and drilled chassis;
  - One dial and escutcheon;
  - One knob for 1/4-in. shaft;
  - Four knobs for 3/8-in. shaft;
  - One special split knob for tuning control;
  - One antenna-ground strip;
  - One A.C. line cord;
  - Three grid caps;
  - One grid cap;
  - Three feet of 5-wire cable;
  - Twenty rivets;
  - One filter choke, Ch1;
  - Four tube shields;
  - Assorted hardware, hook-up wire.
- The name of the manufacturer of the parts in this set will be sent upon request.

Fig. 2

Coil connections for the set.

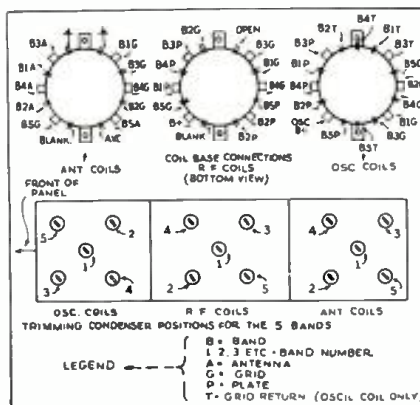

## NEW—EXCLUSIVE SENSATIONAL

Accept... FREE FIVE DAY TRIAL OFFER



TOLEDO'S new speaker assembly with all aluminum baffle housing and adjustable wall mounting bracket

meets every indoor requirement of appearance, adaptability and performance. Improved baffle design greatly increases speaker efficiency and greatly reduces feed-back possibilities. Write for descriptive data on the TOLEDO line of laboratory built sound equipment. Get our prices and let us explain our liberal FREE FIVE DAY TRIAL offer!

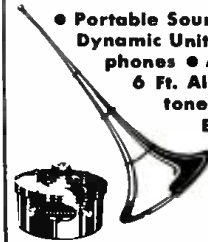

- Portable Sound Systems • Electro-Dynamic Units • Carbon Microphones • Amplifiers • 4, 5 and 6 Ft. All Aluminum Natural-tone Trumpets • Field Exciters • Air Column Horns • Low and High Frequency Units For Wide Range Theatre Use

TOLEDO SOUND EQUIPMENT LABORATORIES

Formerly Bud Speaker Co.

1150 JACKSON STREET • TOLEDO, OHIO, U. S. A.

Special! RADIO PARTS KIT \$1.25

In a recent clearance sale thousands of various radio parts remained. In order to clear our shelves immediately for additional lines, we made up a special assortment of parts and offered them for sale at from 2 to 3 times below their regular price if bought singly. As an added feature we tender the purchaser—absolutely free of additional charge—an all-metal, self-a-tray tool chest and a Radio Servicing Manual.

TRYMO RADIO CO. INC. 85 CORTLAND ST. 179 GREENWICH ST. N.Y.C.

Send in for Free Summer Public Address and Parts Catalog

### IT PAID HIM!



"I HAVE TAKEN several trade courses, but none which have compared with Sprayberry's. It is the best I have ever seen."  
— LLOYD HENDERSSON, Grinnell, Iowa.

... and it will help you, too! A complete, advanced training course for alert Servicemen ONLY. Sprayberry's Practical Mechanics of Radio Service will enable you to do all types of work, quicker, better and more profitably. Priced at but a fraction of the usual course, it will help you stand head and shoulders above competition. Write for FREE BOOKLET to F. L. Sprayberry, 2548 University Place, N.W., Washington, D.C.

"PRACTICAL MECHANICS OF RADIO SERVICE"

Please Say That You Saw It in RADIO-CRAFT

# WELLWORTH TRADING CO. CHICAGO

560 W. WASHINGTON BLVD.

## DO YOU WANT TO OBTAIN AC ELECTRICAL POWER

from a Windmill, from available Waterpower, from your Automobile, from your Motorcycle, from your Bicycle, Footpedals or Handcrank (for transportable Radio Transmitters, Strong Floodlights, Advertising Signs); do you want to operate AC Radio sets from 32 V. DC farm light systems; operate two generators in series to get 200 V. AC; obtain two phase and three phase AC, etc., etc.

## GET OUR WESTINGHOUSE



200 Watt.  
110 V. AC

### Power Generator

MANUFACTURED FOR U. S. SIGN. CORPS

#### SPECIFICATIONS

Weight—14½ lbs. Housing—Aluminum (Diameter—6½ in., Length—5¼ in.) Shaft—2 3/16 in. (driving end) (diameter 9/16 in.—end is threaded for a distance of ½ in.) Base—Cast Iron. (Length—7 ¼ in., Height—1 9/16 in., Width—4¾ in.) Output—200 Watt 110 volts AC (speed 3500 R.P.M.) Stators—Two pairs (two North and two South) Rotor—12 tooth inductor. Built-in commutator. Rotor turns in ball bearings.  
¼ to ½ H.P. needed to run Generator.  
(GENERATORS HAVE NEVER BEEN USED)

**FREE** With each Westinghouse Generator we supply free of charge a set of diagram-blue prints and instructions showing twenty-five different uses, giving technical information, electrical hookups and installing explanations. We also include free of charge a set of four replacement carbon brushes.

### THERE ARE OVER 25 APPLICATIONS

#### SOME OF WHICH ARE:

A.C. Dynamo lighting from eight to ten 20 Watt 110 Volt lamps. Short Wave Transmitter supplying 110 Volts AC for operating "Ham" transmitter. Operating 110 V. AC 60 Cycle Radio Receiver in DC district. Motor Generator. Public Address Systems. Electric Sirens on motor boats, yachts, etc. Camp Lighting. Short Wave artificial "ferret" apparatus. Television. Pelton Waterwheel for lighting or other purposes. Airplane; for lighting strong search lights or electric signs. Laboratory Work.

Generator as described above including four replacement carbon brushes and folder containing instructions and uses..... **\$7.90**

Shipping weight 18 lbs.  
(Replacement carbon brushes bought separate \$1.50 per set of four. Set of instruction bought separate \$1.00.)

All Merchandise Offered in This Ad is Absolutely New and Unused

## Electrical Portable SPRAYER Outfit

**\$27.50**

COMPLETE Formerly Sold for \$68.50

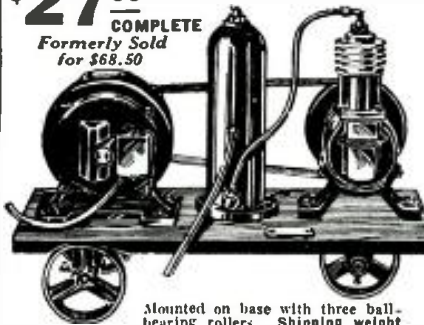

Mounted on base with three ball-bearing rollers. Shipping weight of complete outfit, 55 lbs.

This is the ideal outfit for all-around spraying work wherever current is available. With it you can spray paint, varnish, duco, enamel, lacquer, insecticides, etc., with speed. You can move it from one room to another. Simply insert plug into electric socket and this marvelous machine is ready.

Outfit equipped complete with Internal Mix Spray Gun with quart aluminum cup, which enables you to obtain round or fan spray, 1-1-h.p. heavy duty motor, 110-volt, 60 cycles A.C., and air filter. Kellogg Air-cooled compressor, 1¼x1¼, 15 feet of hose, cord and plug.

Price of complete outfit with gun, \$27.50  
Price of outfit without motor, \$20.00  
Price of Internal Mix Spray Gun, \$7.50 alone  
Price of Filter Tank, \$4.25 alone  
(Complete with Gauge and 60 lbs. Safety Valve)  
Price of Compressor, \$7.50 alone

## G. E. MOTORS

These Motors were manufactured by the General Electric Company and originally intended for use by a large manufacturing company.

Here are the specifications:  
1 30 h.p.—1800 R.P.M. Universal A.C. and D.C. 110 volts instant reverse.  
Size: Diameter 3 inch, length 5 inch. Shipping weight, 3 lbs. Add 25¢ for special packing and mailing anywhere in U.S.A.



**\$2.45** EACH

WHILE THEY LAST

Original Price \$12.00

**ORDER FROM THIS AD**  
SINCE WE DO NOT PUBLISH A CATALOG  
Remit by check or money order for full amount of each item—shipped by express collect, if no money for P.P. enclosed. No C.O.D. Money refunded if not satisfied.

## OPERATING NOTES

(Continued from page 32)

### HOWARD MODEL E14

LIKE most of the small table models, and the corresponding consoles incorporating the same chassis, price has been the governing factor in the manufacture of these sets and, as a result, they have been thrown together with little or no thought as to the final outcome. Take the above set, and most other competitive sets of the same price range and you will find that invariably they all have one glaring fault—inadequate filtering, the result being a very annoying low-pitched A.C. hum. In the Howard E14 and in the others, the field of the speaker is the only choke in the filter and this is usually aided by low capacity electrolytic condensers.

The first set received by this shop for resale was returned to the jobber; it came back as OK, and with the same hum. A new chassis was installed; still the hum persisted.

We now took the matter in hand, cutting the lead from the set to the input of the field coil of the speaker (in the speaker cable) we inserted a midget 30 hy. choke, added a 16 mf. condenser to the input of this new choke and tried the result. The hum had disappeared. This choke and condenser were then added to each set as they were ordered. To do this it was necessary to place a shelf or platform over the power transformer (as there was no room on or under the chassis) and mount the choke and condenser on this. Fig. 2 A and B show schematically how this is done.

R. O. LAMB

### ZENITH MODELS 410, 411, 420

THE most baffling cases of radio trouble are those where the set tests "normal," or near normal, but the operation of the outfit is still not right. Due to the fact that every receiver is full of "tolerances," a Service Man will not question a slight difference in values. If, for instance, a manufacturer's data shows 220 V. to be expected at a certain point, it is generally not abnormal to find 210 V. there.

The several model 410 Zenith receivers that had baffled Service Men were in that category. Everything seemed to test near normal and yet there remained a distinct carrier hum that rode in on every station. There was no noticeable hum between stations and the hum was not bad enough to distort the signals. Still it was there and was not right. The substitution of all new tubes did not change matters.

The only things slightly abnormal shown up by the analyzer were that all plate voltages were slightly low and screen-grid voltages slightly high. Every condenser in the set was individually tested and found to be in perfect condition. Then all the resistors were checked with the manufacturer's data and found to coincide.

As a last resort I decided to make a thorough resistance analysis of everything in the set and when I got to the field of speaker No. 1 I noticed that the resistance between the screen-grid tap and the high-voltage end was lower than the resistance between the screen-tap and the grounded side. Also the total resistance of the field struck me as being a little low considering it was connected right across the "B" line. (I did not have the resistance data of the fields available.)

There seemed nothing else in the set to suspect so I hung to the idea that there was something wrong with this field—like a drowning man clutches a straw.

One other thing made me suspicious of the field. In the schematic wiring diagram, Fig. 3, it looks like the tap was taken off closer to the grounded end than vice versa as I found. There are 5 turns of inductance between the screen-grid and grounded end and 6 turns between the screen-grid tap and the high-voltage end. (See Fig. 3.) Finally, word as to the correct resistance arrived from the distributors in San Francisco. My suspicions were correct. The field was partially shorted, thus putting a greater load on the line and lowering the plate voltages. It also had the effect of moving the tap up and so raised the screen-grid voltages. Replacement of the field cured the carrier hum.

JIM KIRK

WELLWORTH TRADING CO.  
560 West Washington Blvd., Chicago, Ill.

RC-735

I enclose \$..... for which please send me the following:

Name ..... Address .....

City ..... State .....

**SHORT WAVE COIL BOOK**

### Every SHORT-WAVE SET-BUILDER NEEDS THIS BOOK

Every experimenter who has ever tried to build a short wave set knows by experience, the difference between a good and a poor receiver is usually found in the short wave coils. Often you have to hunt through magazines, books, etc., to find the information you require. The present book has been gotten up to obviate these difficulties.

In this book you find every possible bit of information on coil windings. Only the most modern "dope" has been published. Illustrations give, fully full instructions on how to wind coils, but dimensions, size of wire, curves, how to plot them, by means of which any coil for any particular short wave set can be figured in advance, as to number of turns, size of wire, spacing, etc. There has never been such data published in such easy accessible form as this.

Sent to you up on receipt of **25c** in coin or unused U.S. Postage Stamps.

**RADIO PUBLICATIONS,** 101C Hudson St., New York, N. Y.

# PIRATE STORIES

For August  
**A COMPLETE BOOK-LENGTH NOVEL**  
"THE PEARL GANG"  
A Story of the South Seas  
By CAPTAIN RAABE

Also Selected Short Stories of the High Seas by your Favorite writers including Charles Kelly Sinclair, Wallace R. Bamber, and others. The Adventure Log, Captain Hardy's department for readers.

**A GERNSBACK PUBLICATION**  
15c The Copy—On All Newsstands

Please Say That You Saw It in RADIO-CRAFT



## RADIO-CRAFT'S INFORMATION BUREAU

(Continued from page 34)

thrown open and the meter needle will deflect. If the current through the condenser is more than 1/2-ma. per mf., then the condenser is defective.

### "A" ELIMINATOR FOR FARM RADIO SETS

(330) Mr. C. B. Montague, Bronx, N.Y. (Q.) Would like to build an "A" eliminator to use on my farm. The lighting system is a Delco producing 32 volts. I would appreciate the circuit and constants. Will you be kind enough to publish same?

(A.) We are assuming that you are using either a 2 or 4 V. set. The diagram shown in Fig. 330 will supply "A" voltage for either of the type tubes and also "B" voltage. An output from 1/2 to 1 A. can be obtained and sufficient voltage to eliminate one of your "B" batteries. The parts consist of: 1-80 ohm rheostat, R1; 1-16 ohm resistor, R2; 1 0-10 voltmeter and 1 switch. Regulation of the "A" voltage is produced by the rheostat R1.

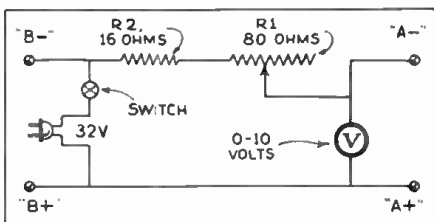

A power unit for 32 V. power systems.

### P. A. QUESTIONS AND ANSWERS

(Continued from page 34)

#### BEST TYPE OF SOUND TRUCK MICROPHONE

(3.) William Brenson, Chattanooga, Tenn. (Q.) What is the best type of microphone for use in a sound truck?

(A.) The best type of microphone to use with a particular installation, is determined to a large extent by the gain of the amplifier with which it is to be used. Low gain amplifiers are limited to carbon mikes unless preamplifiers are to be used, in which case, crystal, condenser, dynamic or a velocity mike may be employed. The following characteristics should be looked for in the selection of an ideal sound truck microphone: compact, rugged, portable, highly damped, shock proof, uniform in frequency response, and immune to wind disturbance. The types of microphones listed in order of their present popularity in sound truck installations follow: carbon, crystal, velocity, dynamic and condenser.

#### ELIMINATING AUDIO FEEDBACK

(4.) Jesse M. Liebermann, Jamaica, L.I. (Q.) What causes and how can I eliminate the audio howling in my automobile P.A. system?

(A.) This condition is caused by the improper placement of the microphone or loudspeaker. If some of the sound coming from the loudspeaker is picked up by the microphone, it is amplified again, and then again fed into the microphone. Therefore a howl at the resonant frequency of the P.A. system is produced. It is remedied in a number of ways: use a highly damped "mike"; change the position of the speaker; sound proof the compartment in which the "mike" is used; use a directional "mike" or a directional sound trumpet with speaker.

#### AUTO POWER SUPPLY

(5.) Mr. Robert Hoffman, Washington, D.C. (Q.) I understand that sound-truck in-

stallations use either generators, motor-generator, rotary converters, or dynamotors for power supply. What is the difference between these devices?

(A.) Generators are machines used to produce electrical power from mechanical motion. The motion supplying device prefixed the generator. Thus, motor-generators are composed of two machines, an electric motor and a generator. Fan-belt driven generators are coupled to automobile fan-belts. Gasoline driven generators are coupled to gasoline engines. Generators are made to produce any desired D.C. or A.C. voltage or current. Rotary converters are rotating machines used to convert D.C. into A.C. or vice versa. Motor-generators are used on 6, 12, 32, 110 or 220 V. Lines to produce higher output voltages.

## RADIO-CRAFT ITEMS OF INTEREST TO SERVICEMEN

(Continued from page 34)

ARTICLE	Issue	Page
*How to Make a Selector Unit For Voltage or Resistance Analyzing	Mar., 1934	533
How to Make an A. C.-D. C. Service Oscillator	Mar., 1934	534
Facts about Dynatron Operation (Part I)	Mar., 1934	535
*How to Select P. A. Equipment	Mar., 1934	536
*How to Install "Replacement Transformers" (Part I)	Mar., 1934	539
Servicing the "Talkies" (Part V)	Mar., 1934	539
Don't "Fight" Your Service Oscillator	Apr., 1934	587
*High-Frequency Adjustments in Receivers	Apr., 1934	593
An Old Tube Tester—Up-to-Date	Apr., 1934	597
Facts About Dynatron Operation (Part II)	Apr., 1934	598
Servicing the "Talkies" (Part VI)	Apr., 1934	601
Give Your Old Tube Tester	Apr., 1934	602
Raising the Ohmmeter Range	Apr., 1934	624
A Fundamental Analyzer	May, 1934	660
Servicing the "Talkies" (Part VII)	May, 1934	665
*RADIO-CRAFT Table of Bias Resistor Values	May, 1934	670
*Determining Transformer Voltages Under Load	May, 1934	695
Uplifting the Servicing Profession (Part I)	June, 1934	725
A Set-Sensitivity Tester	July, 1934	119
*Important Facts about the New All-Wave Antenna Systems (Part I)	July, 1934	20
Auto-Radio Service Hints	July, 1934	24
Speaker Cones	July, 1934	31
Uplifting The Servicing Profession (Part II)	July, 1934	29
Useful Automotive-Radio Reference Information	July, 1934	36
*Important Facts About the New All-Wave Antenna Systems (Part II)	Aug., 1934	54
The P.E. Cell	Aug., 1934	86
Uplifting the Servicing Profession (Part III)	Aug., 1934	88
*Converting Old Sets	Aug., 1934	89
A Versatile Oscillator	Aug., 1934	90
Gas Test	Aug., 1934	95
Testing Reproducers	Aug., 1934	95
Auto-Radio Noise	Aug., 1934	113
A 1 to 15 Megohm "Megger"	Aug., 1934	114
A Small Magnetizer	Aug., 1934	119
Beware—The Service Gyp!	Sept., 1934	144
Repairing Dynamic Cones	Sept., 1934	148
*Converting Old Sets	Sept., 1934	149
How Shielded Lead-Ins Misbehave	Sept., 1934	153
How to Make a Grid-Dip Oscillator	Sept., 1934	154
A Test Bench Supreme	Sept., 1934	160
The All-Wave "1/2-Doublet" Antenna	Oct., 1934	212
Uses of a Neon-Tube Condenser Analyzer	Oct., 1934	214
An Ultra-Small Set Analyzer	Oct., 1934	216
*How to Use the New Tubes	Oct., 1934	217
*Converting Old Sets	Oct., 1934	219
A Compact Tube Tester	Oct., 1934	220
Midget Tube and Set Tester	Oct., 1934	223
A Tuned All-Wave Fine Noise Eliminator	Nov., 1934	281
A Service Man's All-Wave Oscillator	Nov., 1934	282
*Converting Old Receivers	Nov., 1934	284
A Simply Constructed Multi-Volt-Ohmmeter	Nov., 1934	285
"Decade" Resistance Box	Nov., 1934	290
A Test Kit for Antenna Systems	Nov., 1934	308
How to Build a Tubeless "B" Supply	Dec., 1934	344
A Service Man's Pee-Wee Analyzer	Dec., 1934	350
Rattles in Dynamic Speakers At High Outputs	Dec., 1934	352
New Design in All-Wave Antennas	Jan., 1935	413
A Real Service Man's All-Wave Oscillator	Jan., 1935	415
Short-Wave Interference	Jan., 1935	445
New Developments in Interference Elimination	Feb., 1935	475
Build This Versatile Test Instrument	Feb., 1935	476
Resistance-Capacity Tester	Feb., 1935	480
Handy Formula Card	Feb., 1935	480
Phonograph-Record Demonstrator	Feb., 1935	483
Grid-Dip Oscillator	Feb., 1935	483
Be Satisfied to be a Service Man!	Feb., 1935	485
*Replacement Status of the New Tubes (Part I)	Mar., 1935	525
How to Read Radio Diagrams	Mar., 1935	526

(Continued on page 62)

## Train Now for New RADIO Opportunities



Get Into a Line Where There's Action—Every Day—And a Payday Every Week—You Be the Boss!

**Analyzer & Resistance Tester—Latest Design—YOURS Without Extra Cost**

Right now while hundreds are looking for work where there isn't any, the radio service field can use trained men. With the proper training and the necessary equipment, you can enter this field and make a comfortable living. We include with our course this modern set analyzer and trouble shooter without any extra charge. This piece of equipment has proved to be a valuable help to our members. After a brief period of training, you can take the set analyzer out on service calls and really compete with "old timers." We show you how to wire short-wave receivers—analyze and repair all types of radio sets—and many other profitable jobs can be yours. Teaching you this interesting work is our business and we have provided ourselves with every facility to help you learn quickly yet thoroughly. If you possess average intelligence and the desire to make real progress on your own merits, you will be interested.

### ACT NOW—MAIL COUPON

Start this very minute! Send for full details of our plan and free booklet that explains how easily you can now cash in on radio quickly. Don't put it off! Write today. SEND NOW!

RADIO TRAINING ASSN. of AMERICA  
Dept. RC-57, 4513 Ravenswood Ave., Chicago, Ill.

Gentlemen: Send me details of your Enrollment Plan and information on how to learn to make real money in radio quick.

Name.....

Address.....

City..... State.....

.....

.....

.....

.....

.....

.....

.....

.....

.....

.....

.....

.....

.....

.....

.....

.....

.....

.....

.....

.....

.....

.....

.....

.....

.....

.....

.....

.....

.....

.....

.....

.....

.....

.....

.....

.....

.....

.....

.....

.....

.....

.....

.....

.....

.....

.....

.....

.....

.....

.....

### MAKE EXTRA MONEY

A rich new field is open to the Service Man in installing group hearing aids for the Hard of Hearing in theatres and churches. Daily, more theatres are putting in this equipment. YOU are the logical man to sell it to them and to install it.

Become an authority on group hearing installations. Write TODAY.

## TRIMM

RADIO MFG. CO.  
Dept. R7  
1528 Armitage Ave.  
Chicago

Please Say That You Saw It in RADIO-CRAFT

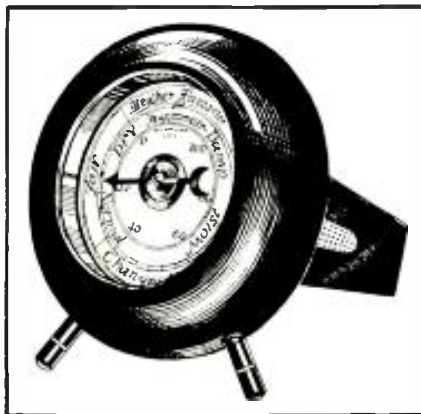

## Something NEW!

### Weather Forecaster and Humidity Tester

## "HYGROSCOPE"

The Ace of Weather Forecasters

When placed in a well-ventilated room or in the fresh air, the HYGROSCOPE foretells coming weather conditions from eight to twenty-four hours in advance. It also accurately records outdoor humidity, and when placed inside it gives the humidity within the house or room.

The HYGROSCOPE is automatic, self-adjustable, simple American-precision made. It cannot get out of order at any time. The dial measures 2 3/4" is enclosed in a 6" round hardwood case, with either walnut or mahogany finish. It is attractive for desk or living room.

### OUTSIDE DIAL FORECASTS WEATHER

Fair—rain—or changeable is indicated on the outer dial when the HYGROSCOPE is placed in a well ventilated room or out-of-doors. If indoors, place the instrument near an open window.

### INNER DIAL SHOWS THE HUMIDITY CONTENT

The HYGROSCOPE also acts as a hygrometer. Numbers on the inner dial indicate the degree of humidity present in the air and in artificially heated rooms.

SEND YOUR ORDER NOW! Get your HYGROSCOPE today. Your remittance in form of check or money order accepted. If you send cash or unused U.S. Postage Stamps, be sure to register your letter. Also specify if you prefer the HYGROSCOPE in Walnut or Mahogany. All orders are shipped immediately.

**\$2.00**  
POSTPAID

MAIL THE COUPON BELOW!

**GRENPARK COMPANY**  
99 Hudson St. New York, N. Y.

GRENPARK COMPANY RC-735  
99 Hudson Street, New York, N. Y.

Enclosed you will find my remittance of \$..... for which send me at once, POSTAGE PREPAID, HYGROSCOPES at Two Dollars each.

Walnut Model  Mahogany Model

Name .....

Address .....

City ..... State.....

(Send your remittance in check or money order. If your letter contains cash or unused U. S. Postage Stamps, be sure you register it.)

## RADIO-CRAFT ITEMS OF INTEREST TO SERVICE MEN

(Continued from page 61)

ARTICLE	Issue	Page
Chart of Radio Symbols	Mar., 1935	527
Testing a Leaky Condenser	Mar., 1935	532
Putting "High-Fidelity" into Old Sets	Mar., 1935	537
Adding a "Tweeter" for High Fidelity	Mar., 1935	543
A Simple All-Wave Oscillator	Mar., 1935	544
Olm's Law with One Meter	Mar., 1935	547
Using Neon Tube As Output Indicator	Mar., 1935	548
*Current-Carrying Capacity of Wire	Mar., 1935	548
Twenty Ways to Use the Electric Eye	Apr., 1935	588
Fundamental Facts About Cathode-Ray Tubes (Part I)	Apr., 1935	594
Resistance Bridge	Apr., 1935	596
*How To Read Graphs and Charts in Radio Work	Apr., 1935	601
A Low Cost A. C.—D. C. Vacuum Tube Voltmeter	Apr., 1935	603
*Replacement Status of the New Tubes (Part II)	Apr., 1935	605
*The Known Frequency Spectrum	Apr., 1935	607
*New Tubes Versus Old	Apr., 1935	610
Cathode-Ray Oscilloscope Uses	Apr., 1935	612
New Ways to Sell P. A. Equipment	May, 1935	650
How to Make Money in the P. A. Field	May, 1935	651
*Facts About the Infinite Baffle	May, 1935	652
The Growth of Public Address	May, 1935	654
A Condenser Tester	May, 1935	659
A Dynamic Speaker Test	May, 1935	659
A 1-Wire Remote Control	May, 1935	659
*Replacement Status of the New Tubes (Part III)	May, 1935	668
Fundamental Facts About Cathode-Ray Tubes (Part II)	May, 1935	672
*Determining Impedances of Transformer Windings	May, 1935	675
The Service Man has the Whip Hand!	May, 1935	677
Vibrator—"B" Test Board	June, 1935	719
Circuits of the Newest Car Sets	June, 1935	722
The Bumper Antenna for 1935—'36 Cars	June, 1935	724
Improvements in Auto-Radio Antennas	June, 1935	727
How to Make a Fidelity-Equalizer Adapter	June, 1935	728
How to Install Replacement Generators	June, 1935	728
Deaf Aid Equipment—A Service Market	June, 1935	728
Obscure Sources of Car Radio Noise	June, 1935	729
Oscilloscope for Vibrator—"B" Testing	June, 1935	730
Typical Bench Set-Up for Testing Vibrators	June, 1935	738
Front-Wheel Static	June, 1935	738
Electrolytic Condenser Tester	June, 1935	739
Vibrator—"B" Service Hints	June, 1935	739
Up-to-Date Service Bench	June, 1935	739

## THE LISTENING POST FOR ALL-WAVE DX-ERS

(Continued from page 57)

with their tests at times, and gives their call in English. DGU is on 9.609mcs. and SUV is on 10.05mcs.

## SHORT WAVE BROADCASTERS OF "JAVA"

This latest official list of short-wave stations in Java should clear up many questions concerning this country's transmissions. This list comes to us from Mr. D.R.D. Wadia, of Bombay, India.

Call Station	Loc.	Frequency	Wavelength	Power
		Kc.	meters	
YDA	Tdk. Priok	6,010	49.69	10 kw.
		3,040	98.68	10 kw.
YDA	Bandoeng	6,120	49.02	1 1/2 kw.
YDB	Soerabaja	4,470	67.11	1 kw.
YDA2	Batavia-C.	2,500	120.00	50 W.
YDA3	Buitenzorg	1,810	162.92	25 W.
YDA4	Soekaboemi	1,550	193.55	25 W.
YDB2	Semarang	2,150	122.15	150 W.
YDB3	Djokja	1,600	180.72	100 W.
YDB1	Tjepoe	1,615	185.96	25 W.
YDB5	Solo	1,535	188.99	25 W.
YDB6	Matang	1,570	191.08	100 W.
YDB2	Bandoeng Inh.	1,650	181.05	50 W.
YDB3	Batavia-C. Inh.	1,585	189.27	50 W.
YDE2	Solo Inh.	4,810	62.37	100 W.
YDE3	Semarang Inh.	2,910	103.09	15 W.
YDE4	Soerabaja Inh.	2,115	124.22	75 W.
YDE5	Djokja Inh.	2,350	127.66	25 W.

Rectifier panel of the Budapest broadcast station.



## AIR CONDITIONING is America's Next Great Industry

THE idea of electricians, radio service men and other mechanically inclined men servicing Air Conditioning and Refrigeration Units is self-evident and the thought has occurred to some untold thousands ever since air conditioning equipment has been installed in public auditoriums, theatres, studios, department stores, office buildings and manufacturing plants. The tremendously broad possibilities in this new industry are bound to give employment and success to men far-sighted enough to see its advancement and development.

### Well-known Engineer Edits Manual

The OFFICIAL AIR CONDITIONING SERVICE MANUAL is edited by L. C. Wright, an expert and a leading authority on air conditioning and refrigeration. In this Air Conditioning Service Manual nearly every page is illustrated; every modern installation and individual part carefully explained; diagrams furnished of all known equipment; special care given to the servicing and installation end. The tools needed are illustrated and explained; there are plenty of charts and page after page of service data.

### CONTENTS IN BRIEF

History of Air Conditioning; Fundamental Laws; Methods of Refrigeration; Elector System of Refrigeration; Compression System of Refrigeration; Refrigerants; Lubricating Oils; Liquid Throttle Devices; Servicing Expansion and Float Valves; Servicing Refrigerating Systems; Control Devices; Thermodynamics of Air Conditioning; Weather in the United States; The Field of Air Conditioning; Insulating Materials; Heat Transmission Through Walls; Complete Air Conditioning Systems; Estimating Requirements for the Home, Small Store, Restaurant; Layout of Duct Systems; Starting Up a System; Operating and Servicing Air Conditioning Systems; Air Filtration, Ventilating and Noise Eliminating Devices; Portable Electric Humidifiers and Room Coolers; Automatic Humidifiers; Air Conditioning Units for Radiator Systems and Warm Air Systems; Central Conditioning Units, etc.



352 Pages  
600 Illustrations

9x12 Inches

Flexible, Loose-Leaf  
Leatherette Cover

**\$5.00** A COPY

(Send remittance by check, money order or unused U.S. Stamps. Register letter if it contains stamps or currency.)

GERNSBACK PUBLICATIONS, INC.  
99R Hudson Street New York, N. Y.

## WONDER Stories NOW

# 15¢ PER COPY

### ON ALL NEWSSTANDS

THE GREATEST EVENT IN THE HISTORY OF SCIENCE-FICTION! This astounding reduction in the price of WONDER STORIES is the culminating step in our struggle to get on top and stay there! Science-fiction has always been an expensive luxury to lovers of action and adventure. NOW it can be enjoyed by everyone at the low prices of ordinary magazines!

If you have never read a science-fiction magazine before, due to their high cost, we heartily advise you to start now with the new popular-priced WONDER STORIES. We want you to buy one issue at your nearest newsstand—and you can get the magazine everywhere—and read it thoroughly. We do not ask you to continue to buy it every month—we know you would not dare to miss an issue after reading the first!

Do yourself a favor—get acquainted with science-fiction now that you can afford it! Unlike most publications, the size and quality of WONDER STORIES is not reduced with the drastic price drop. You get as much for 15c as you could previously get for a quarter.

The July issue contains many unusual, "out-of-the-way," and thoroughly absorbing stories of super-scientific fantasy (including technical, boring, or hard-to-read) by the leading authors in the field, plus one of the greatest murder mysteries ever penned, by a "slick" writer.

Glance through these names: Eando Binder, J. Harvey Langford, Laurence Manning, David H. Keller, M.D., Edmund Hamilton, W. Varick Nevins III, John Boynton Harris, Stanley G. Weinbaum, Philip Jacques Bartel—if you have never seen them before, get acquainted with them—for they are about to become your favorite authors!

**WONDER STORIES**  
99R Hudson St. New York, N. Y.  
**A GERNSBACK PUBLICATION**



# Many Auto-Radios Installed Last Summer Now Need Servicing!

Auto-radios installed during the past six months usually need some minor adjustment—new tubes, new suppressor or other parts. Perhaps the job will even be more difficult—then you'll find how neatly the Auto-Radio Service Manual is to repair the job quickly.

Volume I

\$2.50 LIST

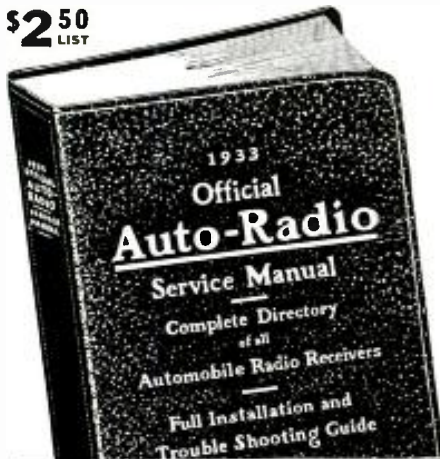

To everyone who now purchases the OFFICIAL AUTO-RADIO SERVICE MANUAL this big 48-page Supplement is issued FREE. Practically all of the latest sets, together with servicing information will be found in these new pages. The new Supplement does not increase the cost of the book to you, but gives you an Auto-Radio Service Manual that is right up-to-the-minute with service notes.

### Good Money in Servicing Auto-Radios

If you are overlooking servicing auto radios, you're missing a great deal of business. The auto-radio business had its greatest boom last summer when thousands of sets were sold. By now many of these same sets require servicing and with hundreds of them right in your own community, you can build up a good auto-radio servicing business. In a short time you can easily add 25% profit or more to your regular servicing business.

### List of sets covered in the Manual

- |                               |                                 |
|-------------------------------|---------------------------------|
| Acme Radio Mfg. Co.           | P. R. Mallory & Co.             |
| Allied Radio Corp.            | Melborn Radio Mfg. Co.          |
| Atwater Kent Mfg. Co.         | Montgomery Ward & Co.           |
| Audiola Radio Co.             | National Co., Inc.              |
| Autocrat Radio Company        | Noblitt-Sparks Intl. Inc.       |
| Automatic Radio Mfg. Co.      | Philco Radio & Tel. Corp.       |
| Carter General Corp.          | Pierce-Algo, Inc.               |
| Century Radio Prods. Co.      | Premier Electric Co.            |
| Chevrolet Motor Company       | Radio Chassis, Inc.             |
| Consolidated Industries, Ltd. | RCA-Victor Co., Inc.            |
| Crosley Radio Corp.           | Sentinel Radio Corp.            |
| Deleo Appliance Corp.         | Sparks-Withington Corp.         |
| Detroit Radio Corp.           | Stewart Radio & Tel. Corp.      |
| Emerson Electric Mfg. Co.     | Stewart-Warner Corp.            |
| Fada Radio & Elec. Corp.      | Stromberg-Carlson Tel. Mfg. Co. |
| Federated Purchaser, Inc.     | Transformer Corp. of Am.        |
| Ford-Majestic                 | United Amer. Bosch Corp.        |
| Franklin Radio Corp.          | United Motors Service           |
| Galvin Mfg. Corp.             | U. S. Radio & Tel. Corp.        |
| General Electric Co.          | Utah Radio Prods. Co.           |
| General Motors Corp.          | Wells-Gardner Company           |
| A. H. Grebe & Co.             | Wholesale Radio Serv. Co.       |
| Grishy-Grunow Co.             | Rudolph Wurlitzer Mfg. Co.      |
| Chas. Hoodwin Company         | Zenith Radio Corp.              |
| International Radio Corp.     |                                 |

Over 200 Pages

Over 500 Illustrations

9 x 12 Inches

Flexible, Loose-Leaf Cover

### MAIL THIS COUPON TODAY!

GERNSBACK PUBLICATIONS, INC. RC-7-35  
99 Hudson Street, New York, N. Y.

Enclosed you will find my remittance of \$2.50 for which please send me One Copy of the OFFICIAL AUTO-RADIO SERVICE MANUAL with FREE 48-page Supplement. Send remittance in check or money order. Register letter if it contains cash or currency. WE PAY POSTAGE.

Name \_\_\_\_\_

Address \_\_\_\_\_

City \_\_\_\_\_ State \_\_\_\_\_

## ORSMA MEMBERS' FORUM

(Continued from page 35)

good the neon tube will flash once and remain out. If the condenser is open the neon tube will not flash at all. If the condenser is leaky, the neon bulb will flash on and off continuously—the more rapid the flashes the greater the leakage.

By substituting the 10,000 ohm resistor with other values, the voltage can be varied.

KAPOURY RADIO SERVICE,  
Greenville, Miss.

## READERS' DEPARTMENT

(Continued from page 30)

started out to see what this idea would do. I went from house to house and talked tubes and aerials.

This idea that they could have a tube or a complete set delivered just by calling seemed to click and the calls did come in. When I have a day with just a few calls, I call on more people and add them to my list. I keep a list of all the people who have bought tubes or service. I intend to call on these people at regular intervals, so they will not forget me and the service I am giving.

So you see if your business has dropped off, you have to go out and get new business. The days that it rains or I cannot get out, I use the telephone.

JAMES R. RIGHT,  
217 W. Warren Street,  
Calumet City, Ill.

## A CORRECTION

We are reproducing below a copy of a letter that Mr. Samuel W. Lichtman wrote one of our readers in regards to the "Low-cost Vacuum Tube Voltmeter," described by him in RADIO-CRAFT for April 1935.

Dear Sir:

I wish to inform you that your contentions are quite correct. The 8Mf. electrolytic condenser referred by you, has appeared in the article through an error in publication. The condenser should have been a 0.5 Mf. paper condenser, in order that the charging current might be kept within safe limits. Furthermore, a paper condenser only should be used in this portion of the circuit in order to prevent the formation of a polarizing current, which also might cause meter damage.

Very truly yours,

Signed, S. W. Lichtman.

## NEW MONEY-MAKING POSSIBILITIES IN A PORTABLE P.A. DEMONSTRATOR

(Continued from page 50)

If the A.F. amplifier and speaker of the radio set should be below par, the wide-awake Service Man now has an excellent opportunity to demonstrate the difference between: (1) a *tone-balanced, high-fidelity amplifier*; and (2) the *audio system of the radio receiver*.

A simple adapter placed under the detector tube of the receiver connects its rectified R.F. (audio) output into the portable high-fidelity tone-balanced amplifier (Refer to diagram) and its associated high-fidelity dynamic speaker.

Once a serious minded broadcast listener hears his receiver through a high-fidelity audio system, nothing short of sheer poverty can keep him from equipping his receiver with this modern audio complement.

Here again, the Service Man has an excellent opportunity to sell a complete high-grade A.F. amplifier and dynamic speaker.

Once this equipment has been set in operation for test purposes, it takes but a moment to connect the microphone to the amplifier and invite the client to listen to his "radio voice."

The irresistible attraction of the microphone, to the average individual, invariably causes the owner or the children of the house to test their voices. The smart Service Man then offers to make a permanent record of the children's voices, or of a favorite radio program. Once the record is played back, the outfit is assuredly sold—at a handsome profit.

(Continued on page 64)

Please Say That You Saw It in RADIO-CRAFT

# TESTING The New METAL TUBES

WILL your present testing equipment measure up to the radically new metal tubes?

Own the NEW "Dependable" Model 305 Tube Tester, and you'll be ready for all comers—today's tubes and future types—without straining your pocket-book.

It is of revolutionary design with exclusive additional service features.

Write Dept. RC-7  
For Complete Data

RADIO CITY PRODUCTS CO.  
28-30 W. Broadway, N. Y.

RAYTHEON PRODUCTION CORP.,  
Dept. E-1, 30 E. 42nd St., New York, N. Y.  
Please send 1935 Tube Chart

Name \_\_\_\_\_

Address \_\_\_\_\_

City \_\_\_\_\_

# RAYTHEON 4-PILLAR RADIO TUBES

## The New EXPLORER All-Wave POWER Converter—

Brings in foreign short wave stations, amateurs, police calls, aircraft, etc., on the loud-speaker of any standard broadcast receiver with amazing volume! Exclusive new "A M O" circuit operates as combined converter and pre-amplifier—and gives tremendous reserve power. Covers 4 bands from 15 to 200 meters. Features include signal indication, dual regeneration, precision calibrated dial, headphones outlet. Users report powerful world-wide reception where expensive all-wave sets fail! Sold on money-back guarantee. Price, less tubes, \$16.95. Send for FREE literature describing this sensational new Radio Development.

RIM RADIO MFG. CO. 689 Grand St., Brooklyn, N. Y.

Radio Dealers & Servicemen!

LARGE, QUICK PROFIT

Sell Sound Equipment to theatres. We supply EVERYTHING! FREE CATALOGS!

S. O. S. CORP.  
1600 B'way., N. Y. C.

## EVEREADY SERVICE CEMENT

"The Original Speaker Cement"

The best Cement for replacing Speaker Cones, and repairing old, rattling, worn Cones, and other Radio Work.

Fast Drying — Vibration Proof  
Ask for it by name, at your jobbers

General Cement Mfg. Co., Rockford, Ill.

**The NEW 1935 148 Page RADOLEK CATALOG Ready Now!**

**Hundreds of New Items!**

RADOLEK'S Revised 1935 Radio Profit Guide contains all the new items recently brought out by leading manufacturers. This big book is a complete radio encyclopedia—accurate descriptions of thousands of radio parts, test instruments, tools, amplifiers, and receivers!

**Valuable Information!**

Diagrams, charts, illustrations! The Profit Guide is more than any ordinary catalog—it is a valuable reference book combining information with product data in such a way as to actually help you in securing more business and in doing your work more rapidly.

**Sharp Price Reductions!**

Lower prices than you have seen in several years! Take advantage of the hundreds of Specials and genuine bargains offered in this, the most complete Radio Servicemen's Profit Guide ever published.

THE RADOLEK CO.,  
612 W. Randolph St., Chicago  
Please rush the PROFIT GUIDE to

Name \_\_\_\_\_  
Address \_\_\_\_\_  
City \_\_\_\_\_  
Serviceman  Dealer  Yrs. Exper.   
Equipment \_\_\_\_\_

**WHEN CHOOSING A RADIO SCHOOL**

RCA Institutes, with its reputation established by 26 years service, is an institution recognized as an important factor in the radio industry. Whether elementary radio principles or advanced subjects, sound applications or practical radio engineering, RCA Institutes is prepared to give you the instruction you need.

**RESIDENT SCHOOLS NEW YORK AND CHICAGO** with modern standard equipment  
**EXTENSION COURSES FOR HOME STUDY** under convenient "no obligation" plan  
Illustrated Catalog on Request.

**R. C. A. INSTITUTES, Inc.** Dept. RT-35  
75 Varick St., New York—1154 Merchandise Mart, Chicago

**RESISTOR SPECIALISTS**

Featuring:

- QUIET VOLUME CONTROLS, built on an entirely NEW principle.
- VITREOUS RESISTORS
- TRUVOLT RESISTORS
- POWER RHEOSTATS

Write Dept. RC-7 for Catalog

175 Varick St., New York, N.Y.  
**ELECTRAD**

**NEW MONEY-MAKING POSSIBILITIES IN A PORTABLE P.A. DEMONSTRATOR**

(Continued from page 63)

**PRACTICAL EVERYDAY APPLICATIONS**

Mr. Robert Hoffman, sales manager of the company, used the equipment illustrated in the foreground of the photo. A record was carefully prepared extolling the virtues of the deluxe model dryer. The patter was given by a professional announcer who used the first person throughout his talk. A similar record was also prepared for the Junior Model Dryer. All of the recording and P.A. equipment, with the exception of the microphone, was judiciously hidden from sight—one speaker behind each dryer, and the amplifier, turntable and mixer behind a small table.

A short announcement through the microphone attracted the desired attention of the people in the vicinity of the booth. One of the records was played through the amplifier while a bright spotlight illuminated the dryer which was being described. As the record finished with an appropriate introduction, to the Junior Model, another spotlight shifted the attention of the spectators to the smaller dryer. By this time, the second record had started, resulting in aural illusion of the sound source actually having moved from one dryer into another. This amazing demonstration created considerable attention at the show and resulted in many sales for the dryer company and innumerable prospects for the Service Man, (Mr. Charles Seidman, New York City—Editor) who handled the installation.

**THE EQUIPMENT**

Of course, the exact type and complexity of equipment required for any type of recording is determined to a large degree by the available material on hand, and the type of recording required.

To meet every type of recording requirement, the Columbia Sound Co. has developed a series of five different types of recorders ranging in operating scope from simple recording with an ordinary radio receiver, to elaborate "dubbing" of one or more programs onto one record with mixing and fading facilities for announcements. Suitable play-back equipment is also provided. The simplest equipment is essentially composed of a recording phono. motor, a combination recorder and play-back unit, and a set of adapters for connection to any standard, or special custom-built short-wave receiver. The entire recorder is housed in a compact portable leather covered case which may be locked up and safely stored when not in use.

**RECORDING TECHNIQUE**

In view of the fact that once a recording is started it must be continued without interruption clear through to the end (if a continuous track is desired) it might sometimes be desirable to combine onto one record the best portions of a number of recordings. This can easily be done by "dubbing" or recording the desirable short sequences of a number of discs, together with local remarks, onto one disc.

The correct procedure to follow is to lightly chalk mark the outer limits of the recording to be dubbed. These records are arranged in sequence alongside an auxiliary turntable. The playback pickup is connected to the input of the amplifier while the cutting head is connected to the output.

For an effective presentation the record starts with a short announcement followed by a gradual fade out of the voice and a fade in of the first portion of the foreign program. As the playback pick up nears the limit of the desired portion of the recording, the announcer is signalled to start talking. The operator, who is monitoring the program with earphones, gradually fades the record "out" and the announcement "in." While the announcement is being made, the second record is placed in position and the playback motor started. One again the announcer is gradually attenuated and signalled to "stop" after the second recording has been accentuated to the required degree. This procedure is followed until all of the desired programs have been dubbed onto one record. These recordings if properly prepared, will literally represent an unusual array of sound. The author will answer all questions.

**Index to Advertisers**

<b>A</b>	
Aerovox Corporation.....	57
Allied Radio Corporation.....	41, 55
Alloy Transformer Corp.....	52
Audio-Tone Oscillator Company.....	53
Autopower, Inc.....	47
<b>C</b>	
Capitol Radio Research Labs., Inc.....	46
Carmi Transformer Works.....	55
Central Radio Laboratories.....	42
Classified Section.....	51
Coast-to-Coast Radio Corp.....	52
Columbia Sound Systems.....	50
Cornell-Dubilier Corp.....	48
Coyne Electrical School.....	1
<b>E</b>	
Eagle Radio Company.....	50
Electrad, Inc.....	64
Electrical Winding Corp.....	50
Electronic Appliance Company.....	48
<b>F</b>	
Freed Radio Company.....	49
<b>G</b>	
General Cement Company.....	63
General Transformer Corp.....	47
Grenpark Company.....	62
<b>H</b>	
Hammarlund Mfg. Company.....	43
Hygrade-Sylvania Corp.....	41
<b>I</b>	
International Resistance Company.....	51
<b>K</b>	
Kato Engineering Company.....	48
Ken-Rad Corporation.....	57
<b>L</b>	
Lynch, Arthur H., Inc.....	52
<b>M</b>	
McGraw-Hill Book Company.....	55
Macy Engineering Company.....	52
M & H Sporting Goods Company.....	44
Marlo Products Company.....	16
Midwest Radio Corp.....	49
The Muter Company.....	39
<b>N</b>	
National Radio Institute.....	3
National Union Radio Corp.....	57
<b>O</b>	
Oxford Radio Company.....	51
<b>P</b>	
Plan Shop, The.....	54
Popular Book Corp.....	56
<b>R</b>	
Radio Amplifier Laboratories.....	48
Radio Circular Company.....	51
Radio City Products Company.....	63
Radio Electric Service Co.....	39
Radio Publications.....	58, 60
Radio Trading Company.....	46
Radio Training Association.....	61
Radolek Company.....	61
Raytheon Production Corp.....	61
RCA Institutes, Inc.....	61
RCA Mfg. Co., Inc.....	38
Readrite Meter Works.....	40
Remington Rand, Inc.....	54
Rim Radio Mfg. Company.....	63
<b>S</b>	
S. O. S. Corporation.....	63
Servicemen's Pub. Company.....	61
Shure Brothers Company.....	50, 42
Solar Mfg. Company.....	44
F. L. Sprayberry.....	59
Supreme Instruments Corp.....	.....Inside Front Cover
<b>T</b>	
Thor Radio Company.....	53
Thordarson Elec. Mfg. Co.....	43
Toledo Sound Equipment Labs.....	59
Trimm Radio Mfg. Co.....	61
Triplet Elec. Instrument Corp.....	45
Triumph Mfg. Company.....	47
Try-Mo Radio Co., Inc.....	59
<b>U</b>	
Universal Microphone Company.....	48
<b>W</b>	
Wellworth Trading Company.....	60
Weston Electrical Instrument Corp.....	.....Back Cover
Wholesale Radio Service Company.....	53
Wright-DeCoster, Inc.....	44

(While every precaution is taken to insure accuracy, we cannot guarantee against the possibility of an occasional change or omission in the preparation of this index.)



# ANNOUNCING

The 1935

Official

## AUTO-RADIO SERVICE MANUAL



### Volume II

Over 240 Pages  
Printed on Special  
Thin "Bible Paper"

Over 500 Illustrations

Flexible, Looseleaf  
Leatherette Cover

**GUARANTEED  
PUBLISHING DATE  
June 15, 1935**

HERE NOW— is the second volume of the OFFICIAL AUTO-RADIO SERVICE MANUAL—the 1935 Edition.

With so large a number of new auto-radio sets placed on the market by different manufacturers, the 1935 OFFICIAL AUTO-RADIO SERVICE MANUAL becomes an essential part of Service Men's equipment. Remember, there are nearly 1,800,000 auto-radio sets in use today.

The 1935 OFFICIAL AUTO-RADIO SERVICE MANUAL (Volume II), contains 100% new material. It gives schematic diagrams, chassis layouts, mounting instructions, and trouble-shooting hints on all modern auto-radio receivers, and older models as well.

THERE IS ABSOLUTELY NO DUPLICATION OF MATERIAL BETWEEN THE 1933 EDITION (VOLUME I) AND THE NEW 1935 EDITION (VOLUME II). THE MATERIAL IS 100% NEW.

Every radio man connected in any way with the booming auto-radio business needs a copy of the new OFFICIAL AUTO-RADIO SERVICE MANUAL. It contains only auto-radio service "dope."

### HERE ARE ADDITIONAL HIGHLIGHTS OF THE NEW, 1935 EDITION OF THE OFFICIAL AUTO-RADIO SERVICE MANUAL

- 240 big pages crowded with diagrams, service material and other essential data required for proper servicing of new auto-radio receivers. Included are diagrams of sets which appeared during 1934, and which were not included in the supplement to the first edition.
- Complete schematic diagrams, chassis layouts, voltage tabulations and servicing instructions are included for practically all sets. "Under-side" tube symbols are also included to facilitate the job of servicing the sets.
- Instructions are included with many sets telling how to suppress stubborn cases of ignition interference. This includes the newest "suppressorless" sets—and what to do when interference is encountered with this type of set.
- Details on how to make installation in "turret-top" cars are included. The different methods used by car makers and set manufacturers are listed with the individual circuits and service information.
- The index contains the listing of sets which were published in the first edition, as well as the sets which appear in the new volume. This information helps the Service Man to locate the circuit and details for any receiver that has been made.
- The book is bound in a handy, flexible leatherette cover. To be sure the pages are sturdy, to withstand constant use, the book will be printed on a special "bible" stock. This is a very durable, but thin paper. The book printed on this paper can be easily rolled to fit into your pocket or slipped in the service kit.

### MAIL COUPON TODAY!

GERNSBACK PUBLICATIONS, Inc. Dept. RC-735  
99 Hudson Street, New York, N.Y.

Enclosed you will find my remittance of \$2.00 for which send me One Copy of the 1935 OFFICIAL AUTO-RADIO SERVICE MANUAL (Volume II) at the special pre-publication price. I understand that the book will be \$2.50 as soon as it is published. (Send remittance in check or money-order; register letter if it contains cash or currency). The book will be ready on or before June 15th.

Name.....

Address.....

City..... State.....

(The 1935 OFFICIAL AUTO-RADIO SERVICE MANUAL is shipped postage prepaid.)

*Special  
Pre-Publication  
Offer!*

You now have the opportunity to order the 1935 OFFICIAL AUTO-RADIO SERVICE MANUAL before it comes off press. . . you will save money.

The list price of this book is \$2.50. AT THE SPECIAL PRE-PUBLICATION PRICE YOU CAN BUY THE BOOK FOR \$2.00. THIS IS THE FIRST AND ONLY ANNOUNCEMENT WHICH WILL BE MADE BEFORE THE BOOK IS PUBLISHED. IT IS OUR GUARANTEE THAT THE BOOK WILL BE READY FOR DELIVERY ON OR BEFORE THE 15th of JUNE. ONCE THE BOOK IS PUBLISHED, THE LIST PRICE WILL PREVAIL.

**GERNSBACK PUBLICATIONS, INC.**  
99 HUDSON STREET NEW YORK, N. Y.

# WESTON users *Smile* when new tube developments are announced!

"It is certainly gratifying to me to know that with the introduction of new tubes and new circuits the design of my Weston Analyzer is such that it does not have to be discarded each year for a new device."

Yours truly,  
C. J. Kellam  
Elizabeth, N.J.

"With the advent of new tubes and eight prong sockets, my Weston testing outfit will still be up to date. Am I tickled with my choice—figure it out for yourself!"

Yours very truly  
Frank Mirabella  
Brooklyn, N.Y.

The Weston Method of Selective Analysis, introduced over two years ago, is basic . . . and does not become obsolete with circuit and tube developments. It is available in several Weston Analyzer models, in price ranges to suit any pocketbook.

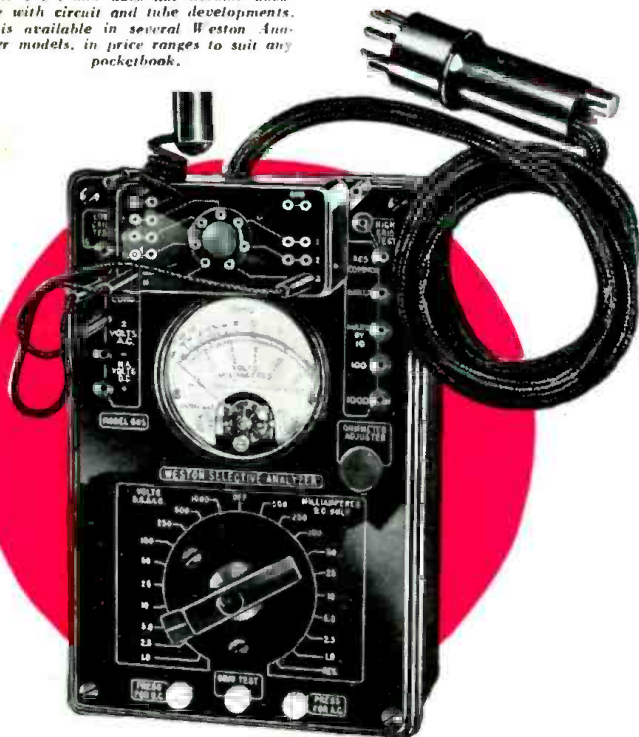

It pays to buy soundly engineered test equipment. The announcement of the all-metal tube has brought this home forcibly to servicemen.

No serviceman who uses the Weston Method of Selective Analysis is faced with the purchase of a new analyzer; nor is the Weston organization faced with the necessity of hastily turning out an expediency job to meet this new tube emergency.

The Weston Selective Analyzer was designed and built from the serviceman's point of view; to provide him with a dependable instrument that would meet all emergencies, and remain serviceable today, tomorrow and even years hence. This is typical Weston engineering.

It explains why Weston instruments are standard not only throughout the radio industry, but throughout the entire electrical industry as well. It offers a sound reason why your instrument purchases should be Weston, for all servicing needs... Weston Electrical Instrument Corporation, 599 Frelinghuysen Avenue, Newark, New Jersey.

**WESTON**   
*Radio Instruments*